

DETAILS

Product Number	FN16258_STELLA-RS
Family	Stella
Type	Lens
Color	clear
Diameter	90 mm
Height	39,15 mm
Style	round
Optic Material	
Holder Material	
Fastening	screw
Status	production ready
ROHS Compliant	Yes
Date Updated	8/12/2017



OPTICAL PROPERTIES

LED	Viewing	Light	Effi-		Connector
	Angle	Beam	ciency	cd/lm	
VERO10	sim: 13	Real spot	sim: 94 %	sim: 11.900-	
V10 Gen7	sim: 14	Real spot	sim: 96 %	sim: 9.918	Bender Wirth: 434 Typ Z1
CLL04x/CLU04x	29 deg	Real spot	94 %	2.400	-
CXA/B 30xx	31 deg	Real spot	94 %	2.300	-
CXA/B 1816 & CXA/B 1820 & CXA 1850	18 deg	Real spot	94 %	6.500	-
CXA/B 25xx	sim: 25	Real spot	sim: 94 %	sim: 3.400	-
COB H-Type	30 deg	Real spot	94 %	2.200	-
COB J-Type	20 deg	Real spot	94 %	5.000	-

H G F E D C B A

4

3

2

1

4

3

2

1

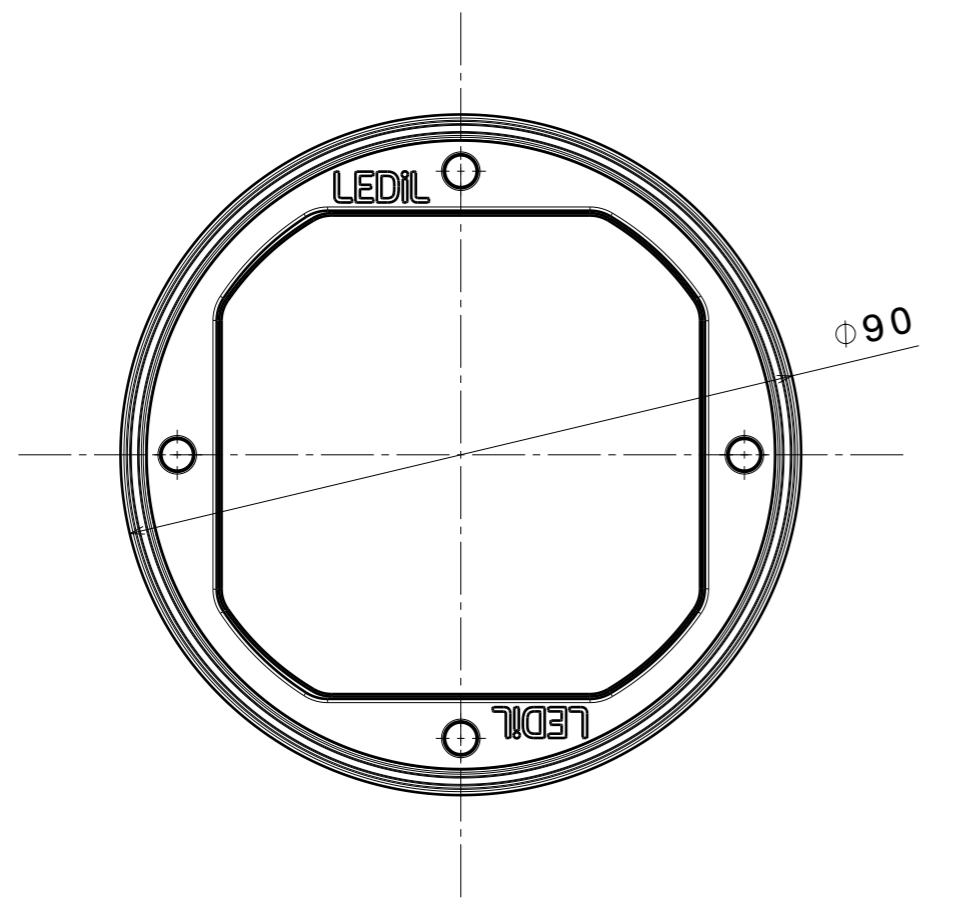

Top view

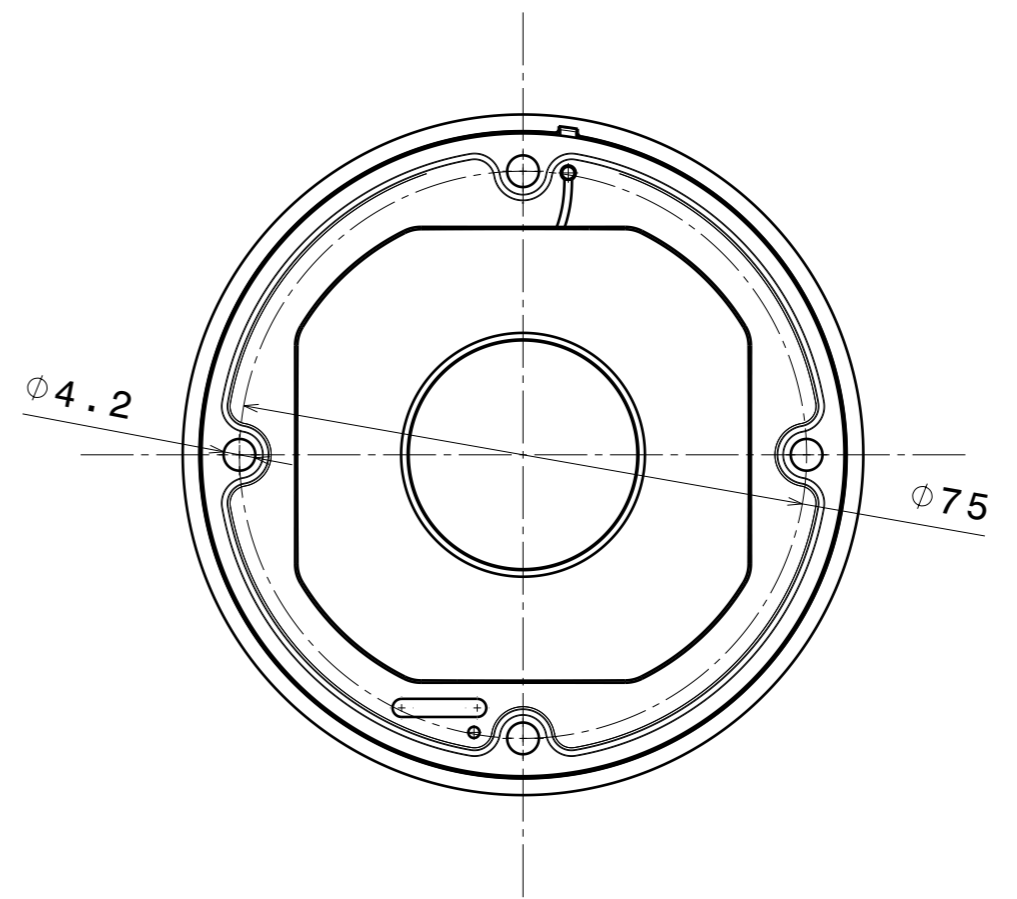

Bottom view

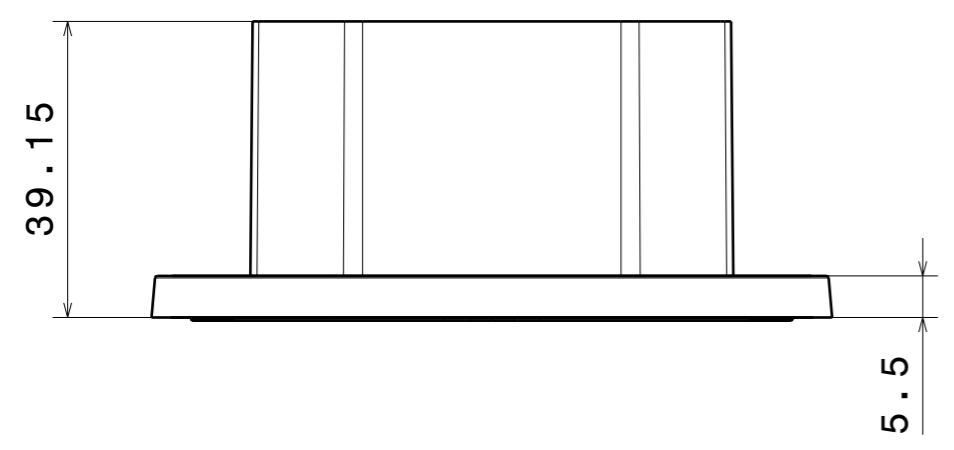

Front view

INDEX	PART NO	DESCRIPTION	MATERIAL	COLOUR
1	F16257	STELLA-RS	Optical grade LSR	
2	F13322	STELLA-FRAME	PA66GF30	black

Tolerances if not otherwise shown
 According to DIN ISO 2768-1
 Linear measures:
 Up to 30mm class M, otherwise class C.
 According to DIN ISO 2768-2
 Form and position: class L

LEDiL LediL Oy
 Salorankatu 10
 FIN 24240 SALO
 Finland

THIRD ANGLE PROJECTION:

DRAWING TITLE
FN16258_STELLA-RS

This drawing is the property of LEDiL Oy. It may not be reproduced, copied or communicated without a written agreement with LEDiL Oy.

SIZE	PART NUMBER
A3	FN16258

SCALE	1:1	WEIGHT	94 g	SHEET	1/1
-------	-----	--------	------	-------	-----

H G B A

Luminaire: Ledil Oy FN16258_STELLA-RS_(VERO10)_SIMULATED
Lamps: 1 x Bridgelux VERO10

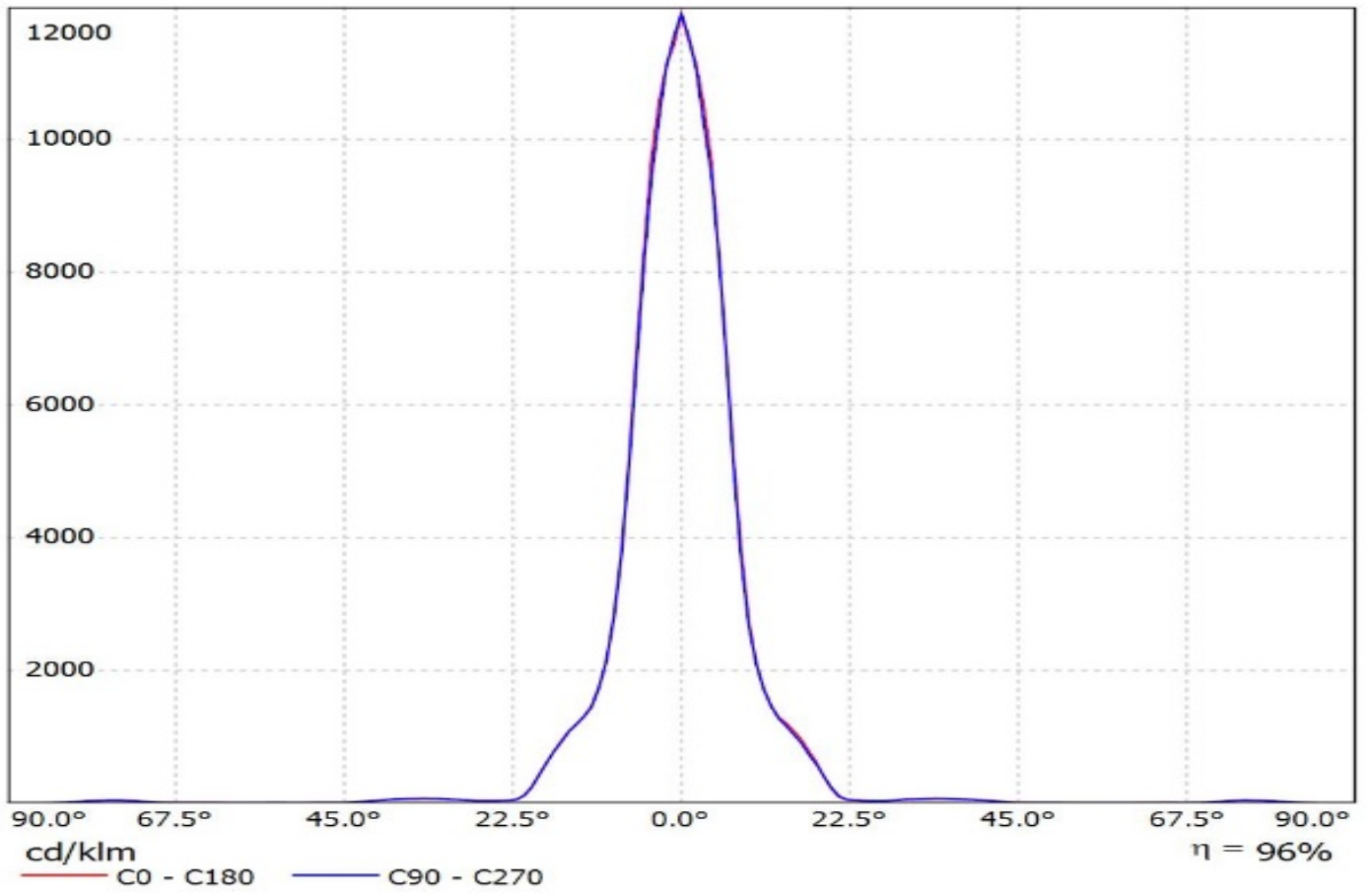

Luminaire: Ledil FN16258_STELLA-RS_(CLU046)

Lamps: 1 x Citizen_CLU046_(CLU046-1212C1-303M2G2)_1346.2lm@250mA_P=8.1135W_U=32.467V

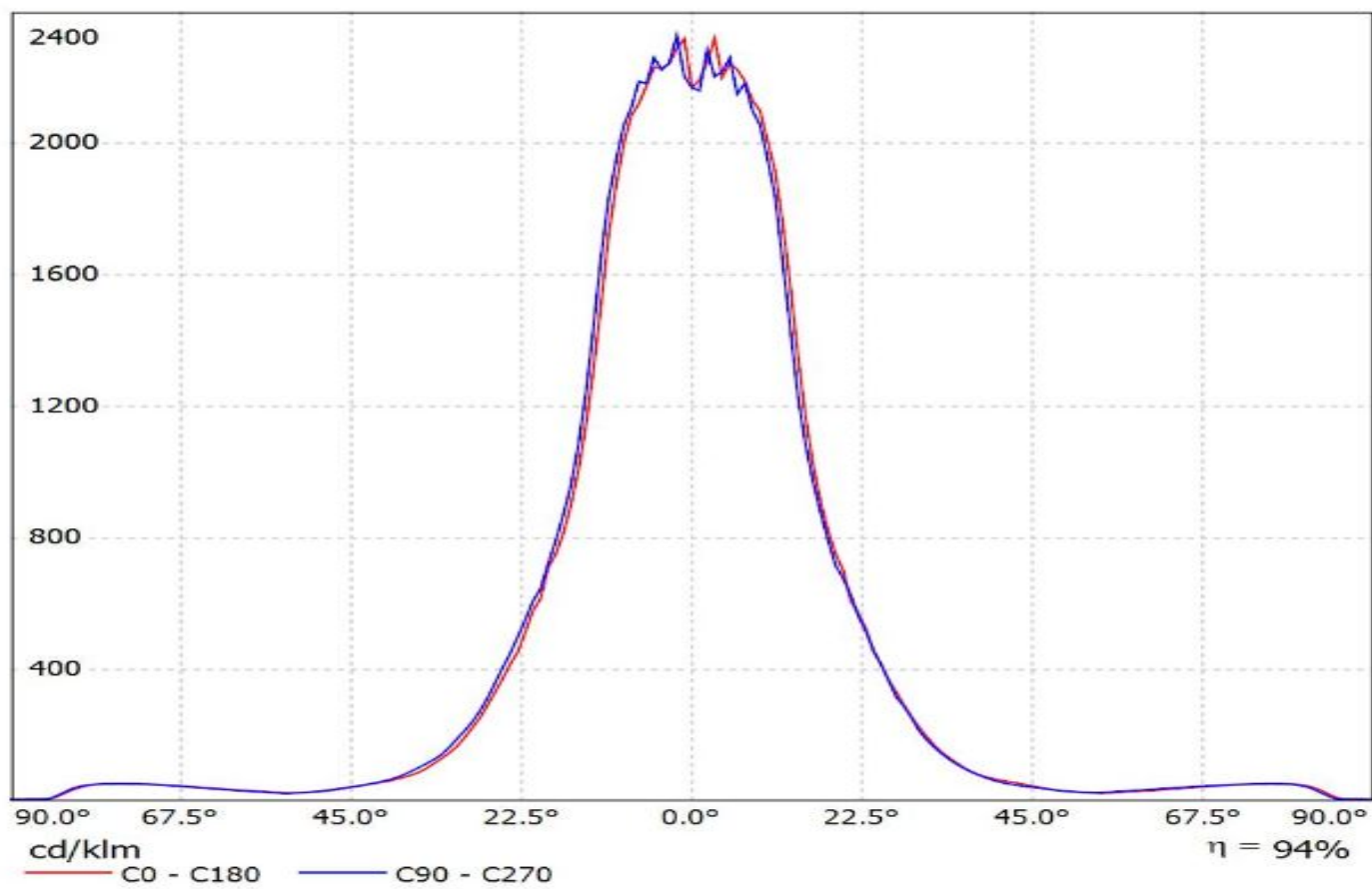

Luminaire: LEDiL Oy FN16258_STELLA-RS_(CXB3050)

Lamps: 1 x Cree_CXB3050_(CXB3050-30G-X4-N0H-001)_1267.32lm@250mA_P=7.86096W_I=0.25A

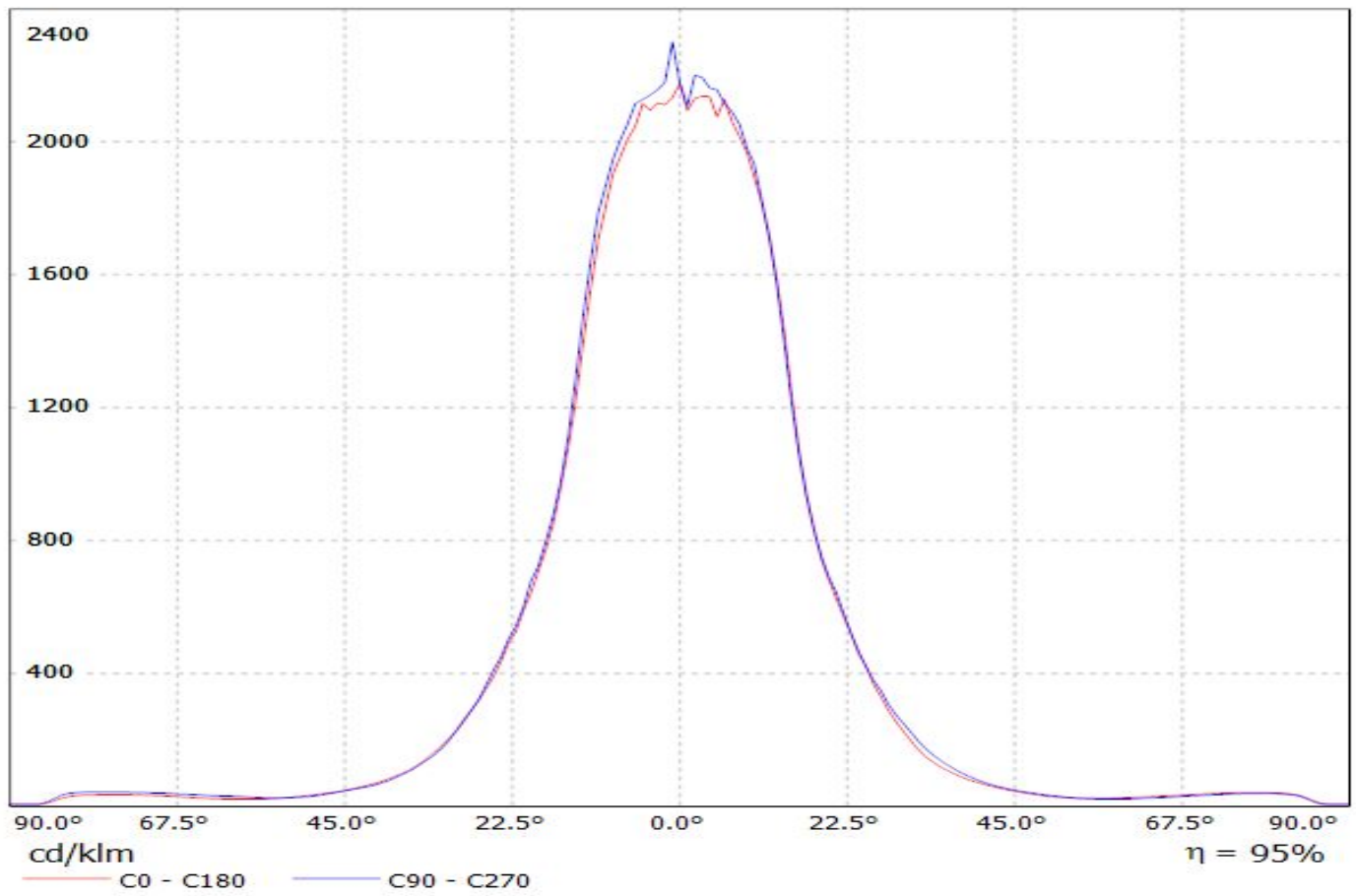

Luminaire: Ledil FN16258_STELLA-RS_(CXB1820)

Lamps: 1 x Cree_CXB1820_(CXB1820-40G-S2-N0H-00001)_1336.39lm@250mA_P=8.38315W_U=33.545V

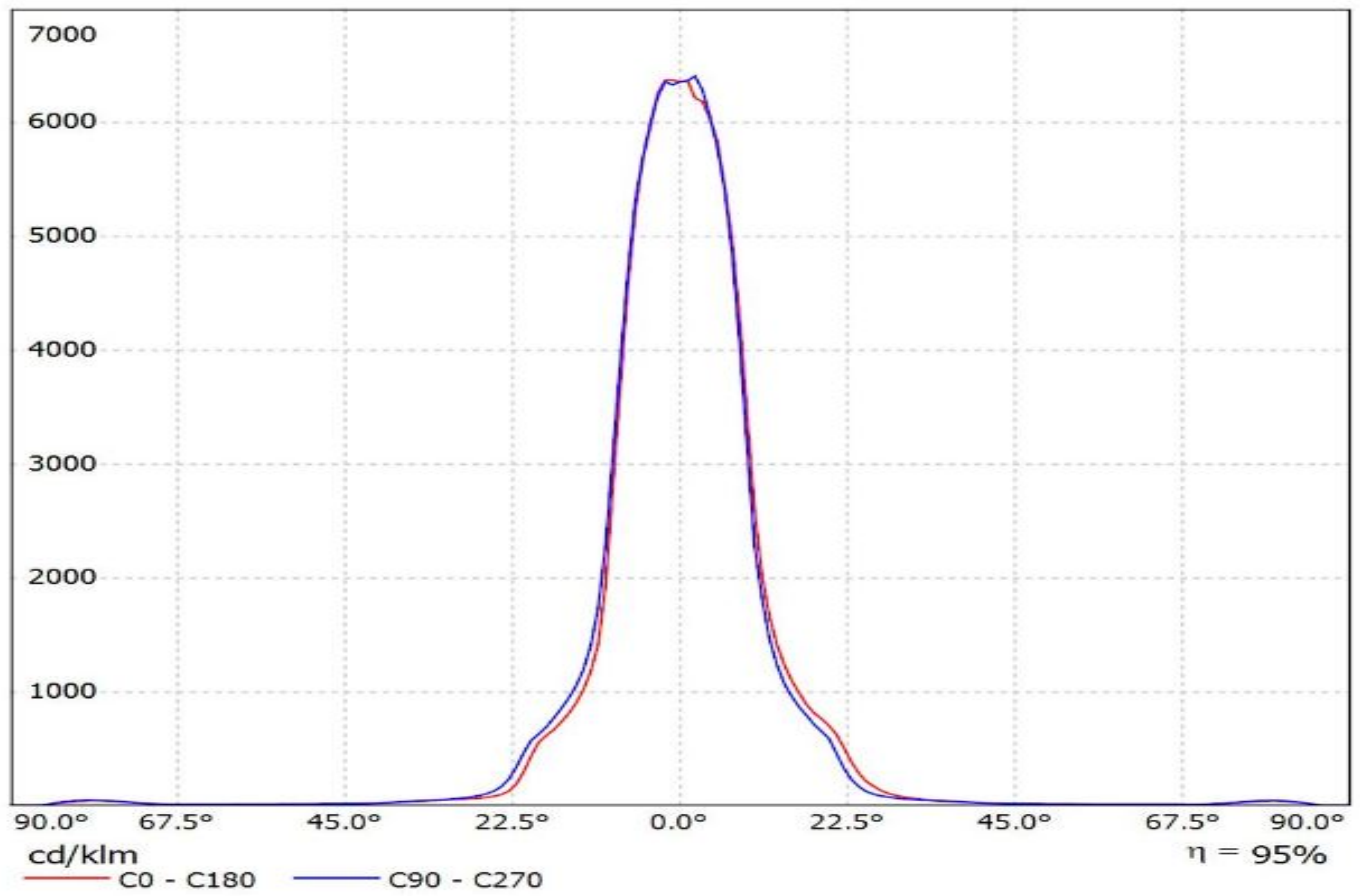

Luminaire: Ledil Oy FN16258_STELLA-RS_(CXB25xx)_SIMULATED
Lamps: 1 x Cree CXB2540

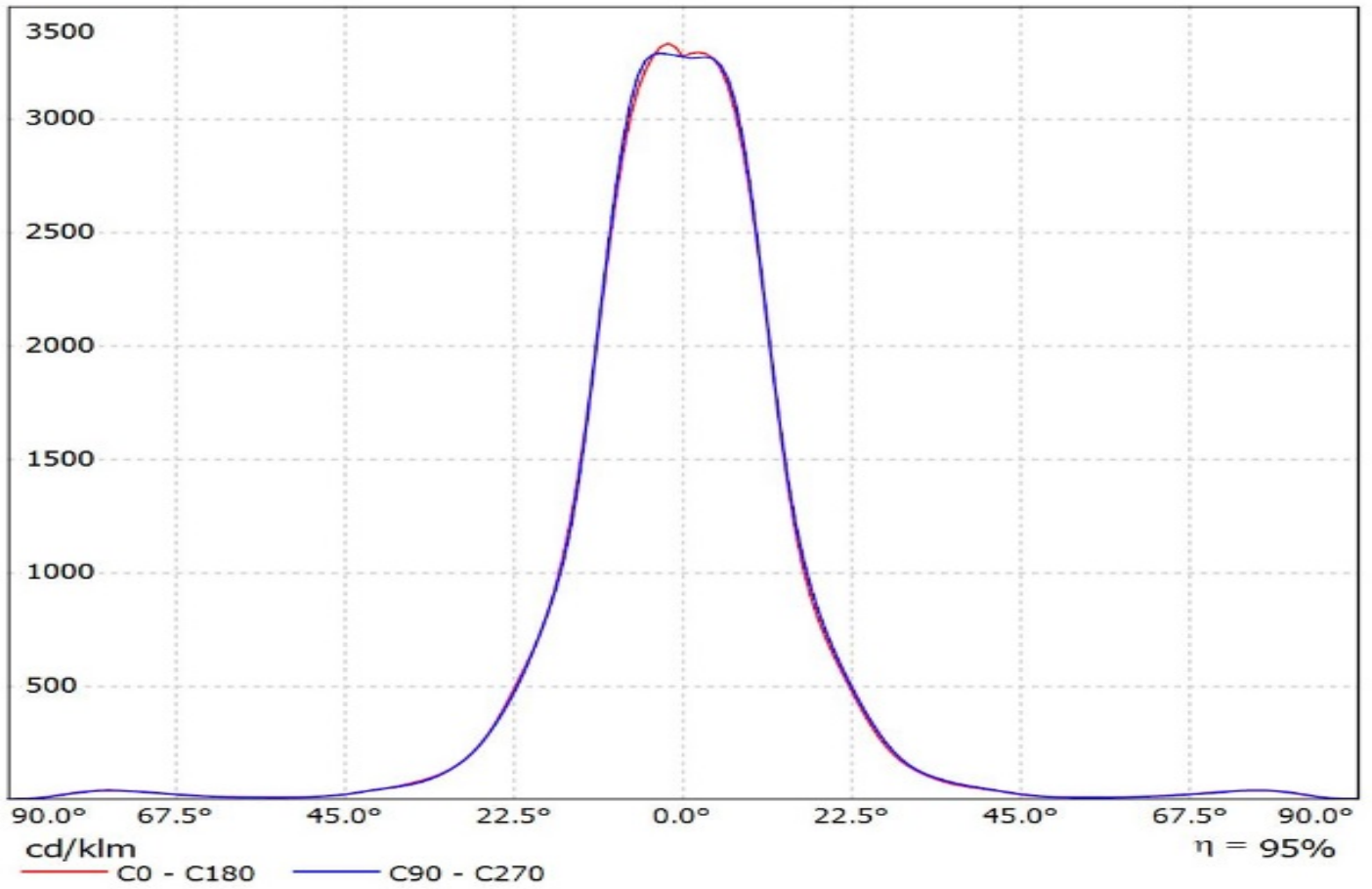

Luminaire: LEDiL Oy FN16258_STELLA-RS_(NFEWH306B-V2E)

Lamps: 1 x Nichia_NFEWH306B-V2E_2183.86lm@250mA_P=11.9135W_U=47.692V

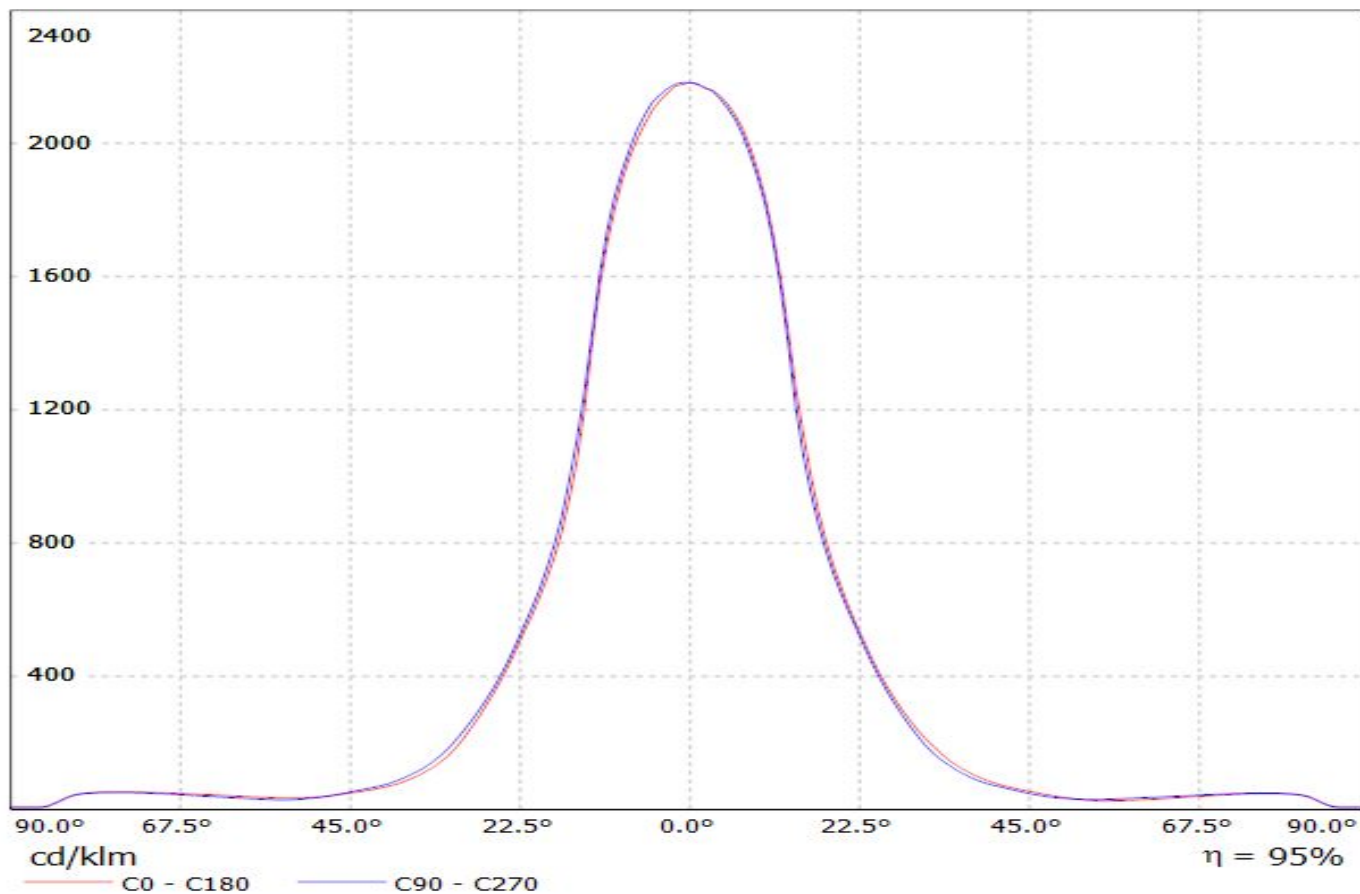

Luminaire: Ledil FN16258_STELLA-RS_(NFDLJ130B)

Lamps: 1 x Nichia_NFDLJ130B_1399.61m@250mA_CCT=4000K_P=8.82847W_U=35.328V

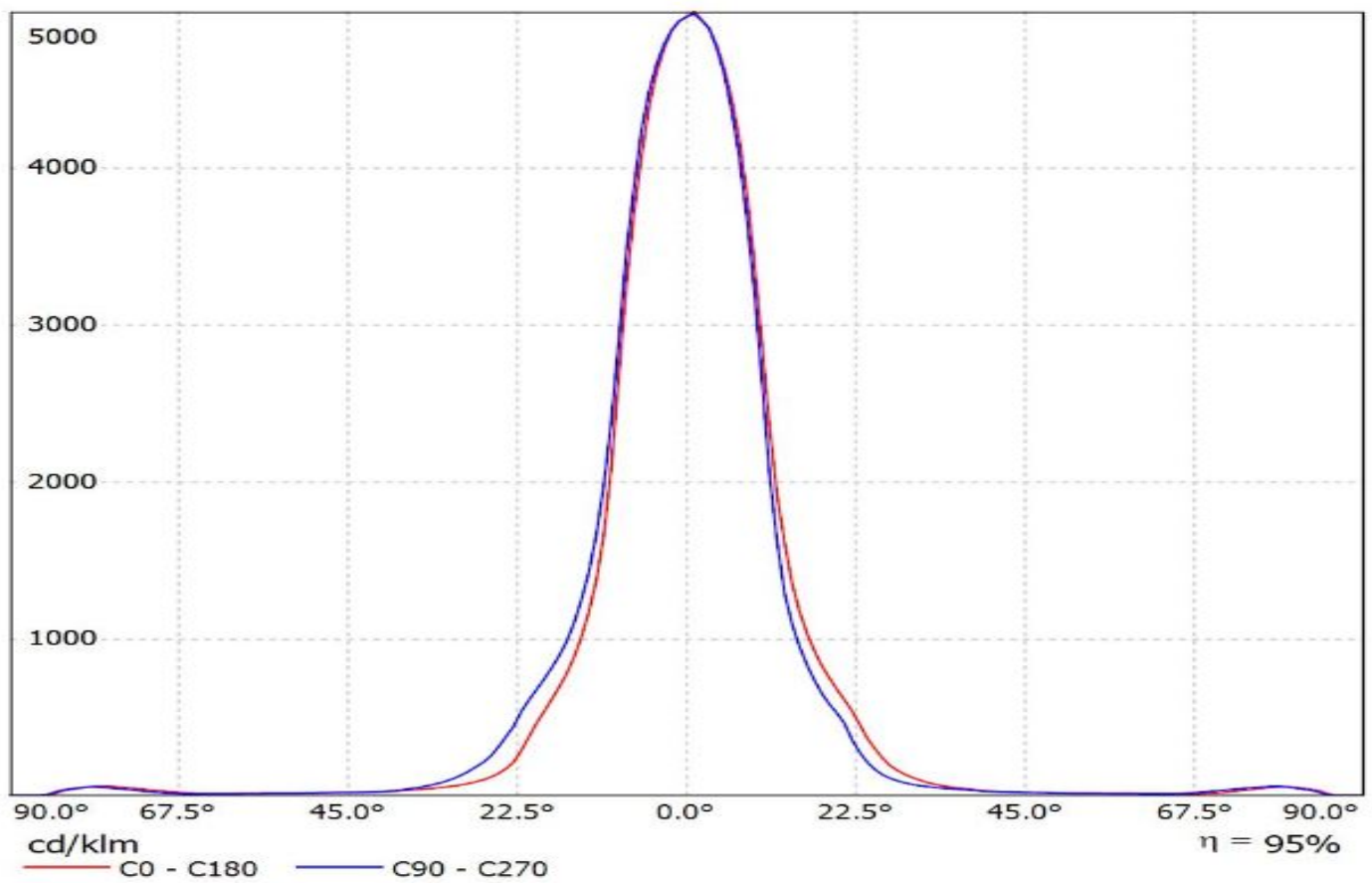

Luminaire: Ledil Oy FN16258_STELLA-RS_(VERO10)_SIMULATED
Lamps: 1 x Bridgelux VERO10

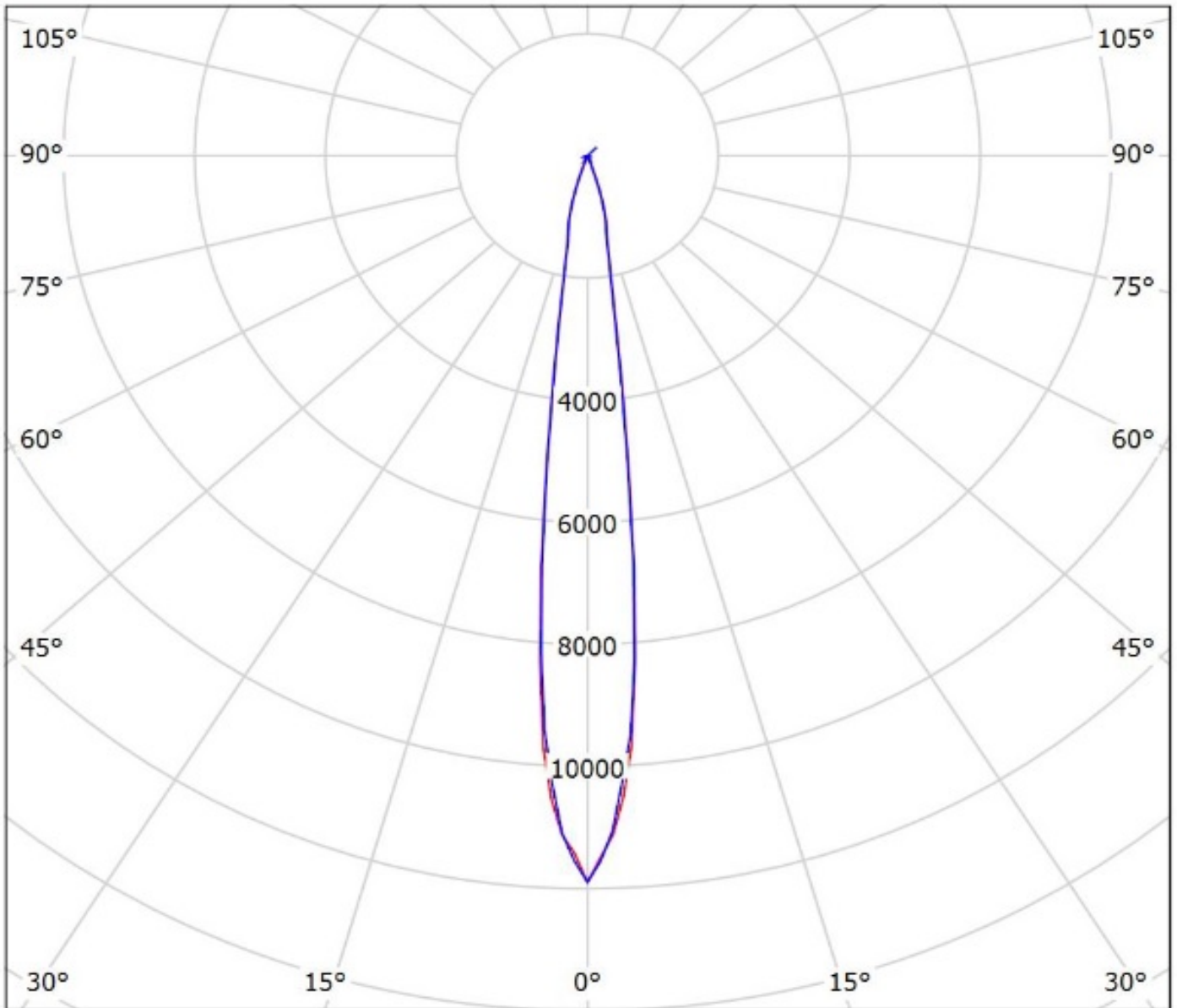

cd/klm

— C0 - C180 — C90 - C270

$\eta = 96\%$

Luminaire: Ledil FN16258_STELLA-RS_(CLU046)

Lamps: 1 x Citizen_CLU046_(CLU046-1212C1-303M2G2)_1346.2lm@250mA_P=8.1135W_U=32.467V

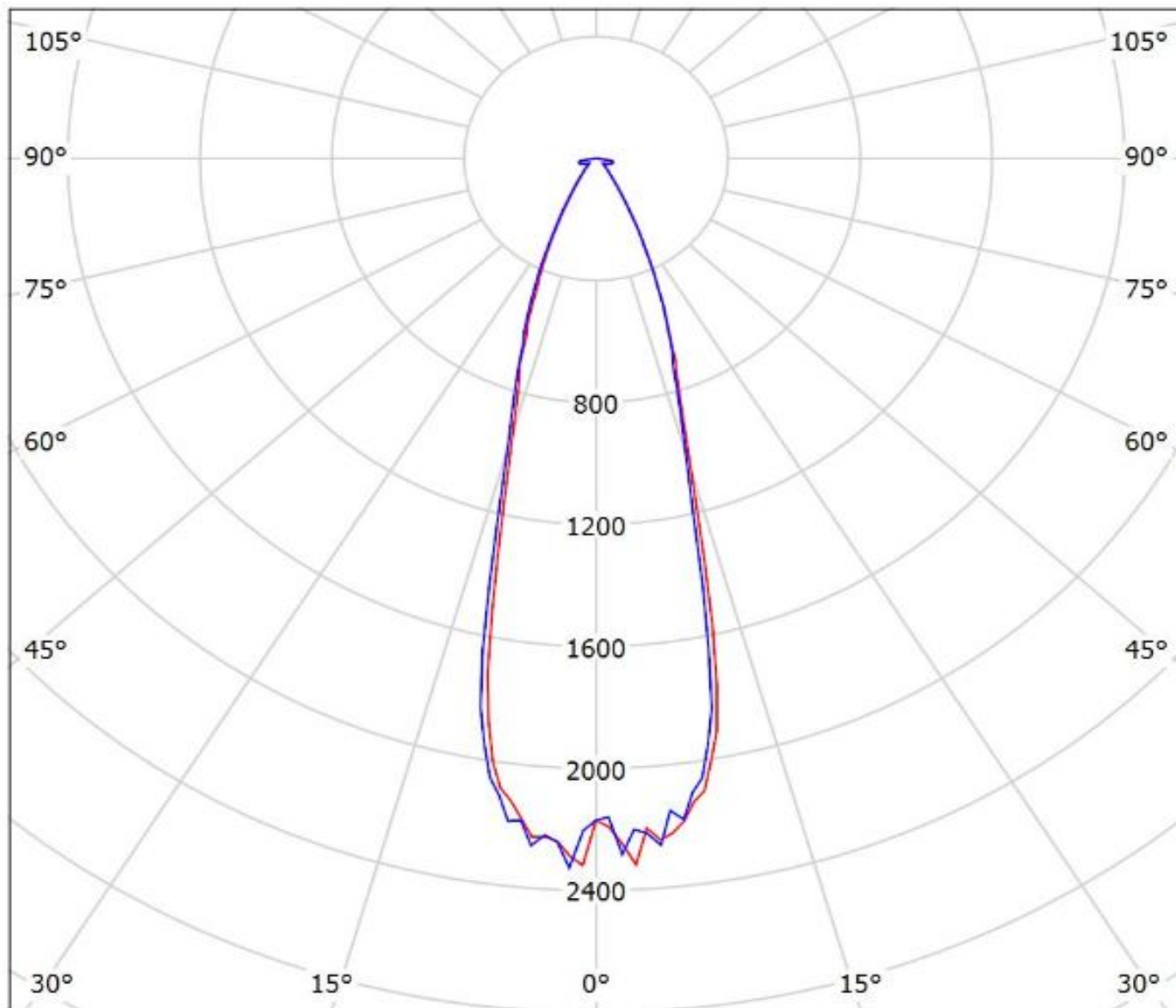

cd/klm

— C0 - C180 — C90 - C270

$\eta = 94\%$

Luminaire: LEDiL Oy FN16258_STELLA-RS_(CXB3050)

Lamps: 1 x Cree_CXB3050_(CXB3050-30G-X4-N0H-001)_1267.32lm@250mA_P=7.86096W_I=0.25A

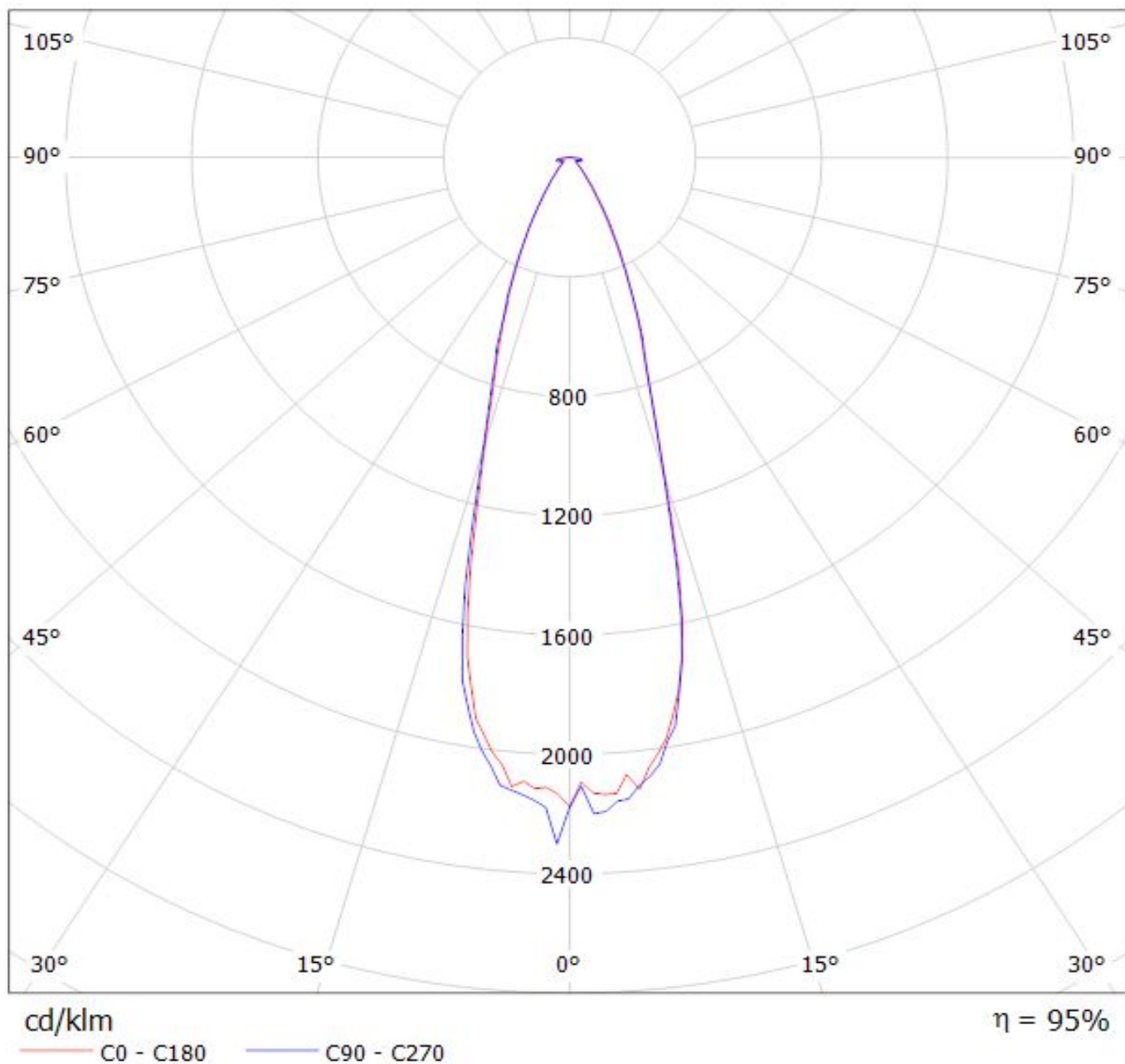

Luminaire: Ledil FN16258_STELLA-RS_(CXB1820)

Lamps: 1 x Cree_CXB1820_(CXB1820-40G-S2-N0H-00001)_1336.39lm@250mA_P=8.38315W_U=33.545V

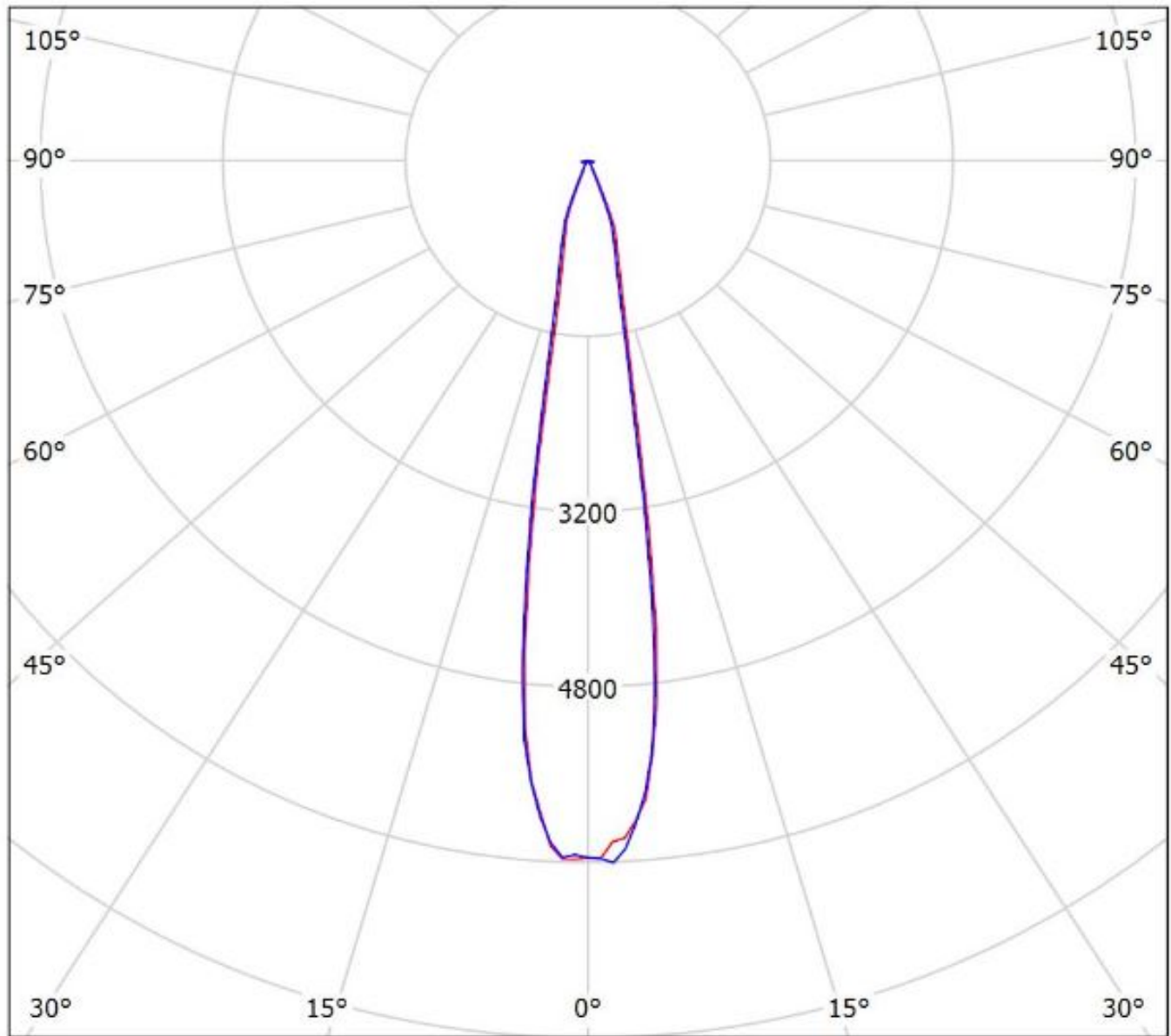

cd/klm

— C0 - C180 — C90 - C270

$\eta = 95\%$

Luminaire: Ledil Oy FN16258_STELLA-RS_(CXB25xx)_SIMULATED

Lamps: 1 x Cree CXB2540

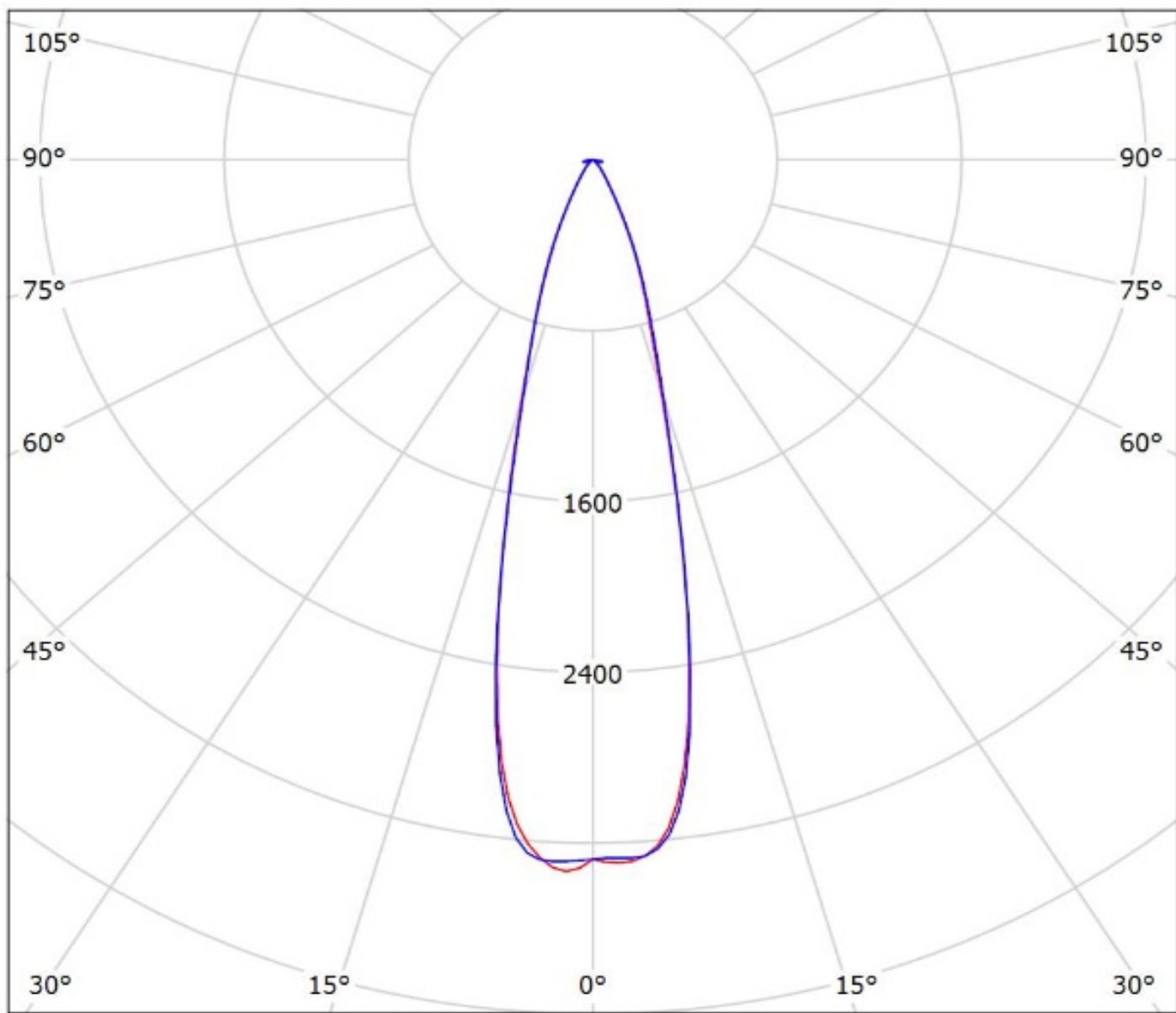

cd/klm

— C0 - C180

— C90 - C270

$\eta = 95\%$

Luminaire: LEDiL Oy FN16258_STELLA-RS_(NFEWH306B-V2E)

Lamps: 1 x Nichia_NFEWH306B-V2E_2183.86lm@250mA_P=11.9135W_U=47.692V

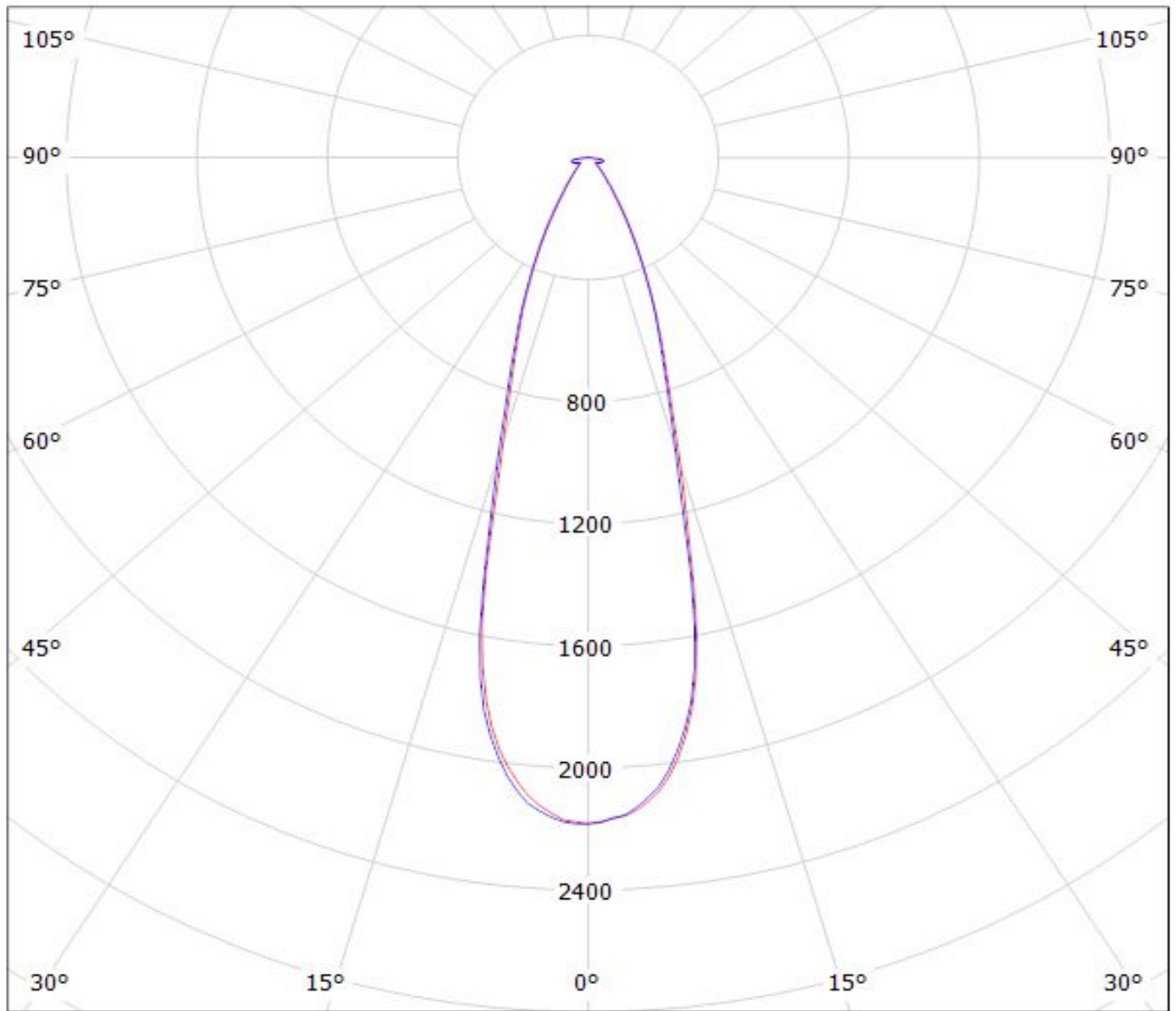

cd/klm

— C0 - C180

— C90 - C270

$\eta = 95\%$

Luminaire: Ledil FN16258_STELLA-RS_(NFDLJ130B)

Lamps: 1 x Nichia_NFDLJ130B_1399.61m@250mA_CCT=4000K_P=8.82847W_U=35.328V

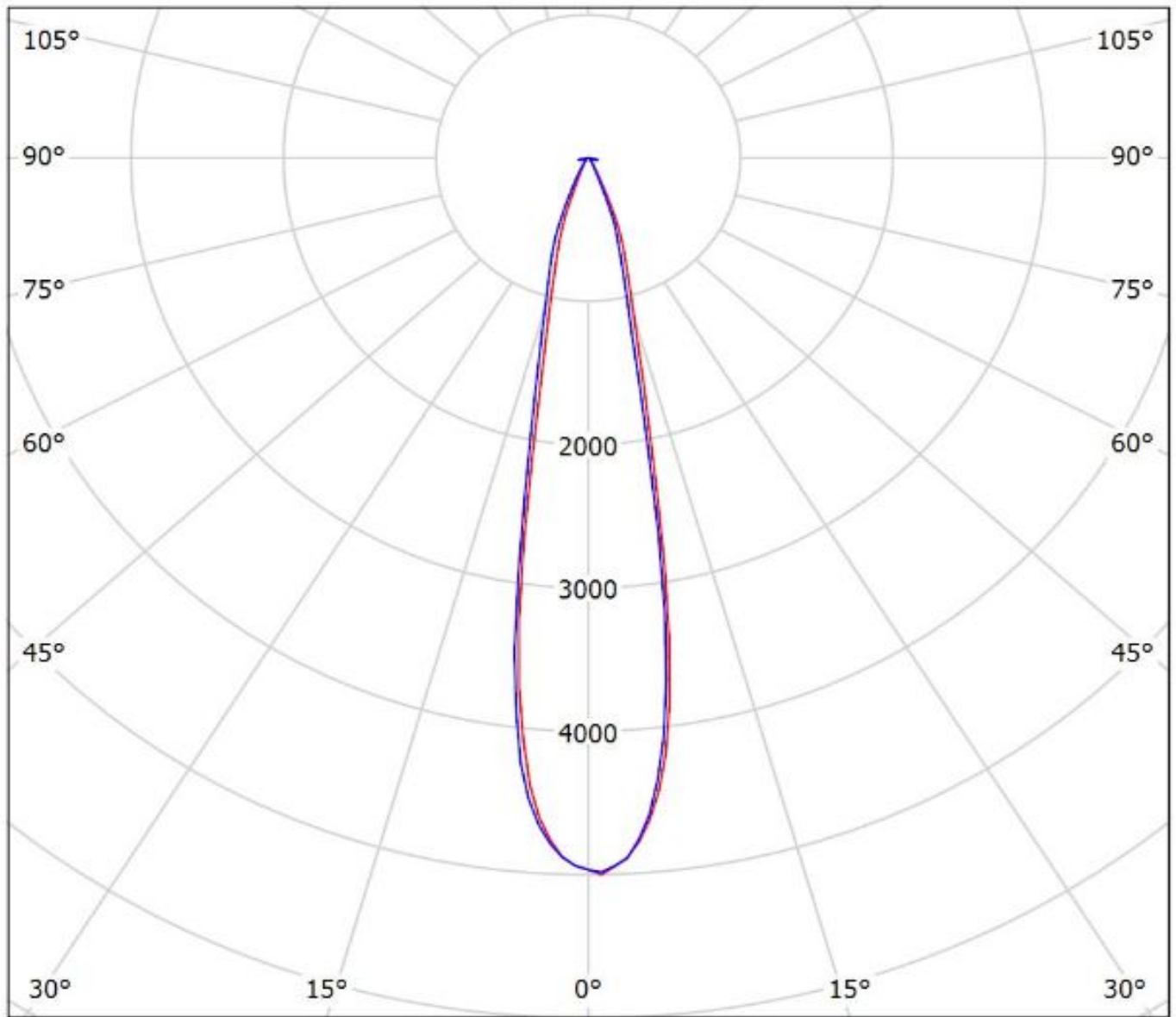

cd/klm

— C0 - C180 — C90 - C270

$\eta = 95\%$

NOTE: The typical divergence will be changed by different color, chip size and chip position tolerance. The typical total divergence is the full angle measured where the luminous intensity is half of the peak value.

GENERAL INFORMATION

- Product series especially designed & optimized for series of LEDs.
- Special care taken to make light distribution as uniform as possible.

Note! Due to use of high power COB's with this product, special attention to proper thermal design is highly recommended. LEDiL has no liability for direct, indirect or consecutive damages arising from the LEDiL products being used outside of the recommended temperature range.