

DETAILS

Product Number	CS16322_STRADELLA-IP-28-HB-S
Family	Stradella
Type	Assembly
Color	clear
Diameter	100 x 100 mm
Height	9,5 mm
Style	square
Optic Material	
Holder Material	
Fastening	pin, screw
Status	sample approved
ROHS Compliant	Yes
Date Updated	15/12/2017



OPTICAL PROPERTIES

LED	Viewing	Light	Effi-		Connector
	Angle	Beam	ciency	cd/lm	
XT-E	sim: 29	HighBay	sim: 92 %	sim: 1.659	-
XP-G3	sim: 38	HighBay	sim: 91 %	sim: 1.300	-
LUXEON 3030 2D	sim: 27	HighBay	sim: 92 %	sim: 2.028	-
NVSxE21A	sim: 25	HighBay	sim: 92 %	sim: 2.096	-
LH351B	sim: 33	HighBay	sim: 94 %	sim: 1.803	-
LH351C	sim: 37	HighBay	sim: 94 %	sim: 1.585	-
Z8Y22	sim: 29	HighBay	sim: 92 %	sim: 1.525	-

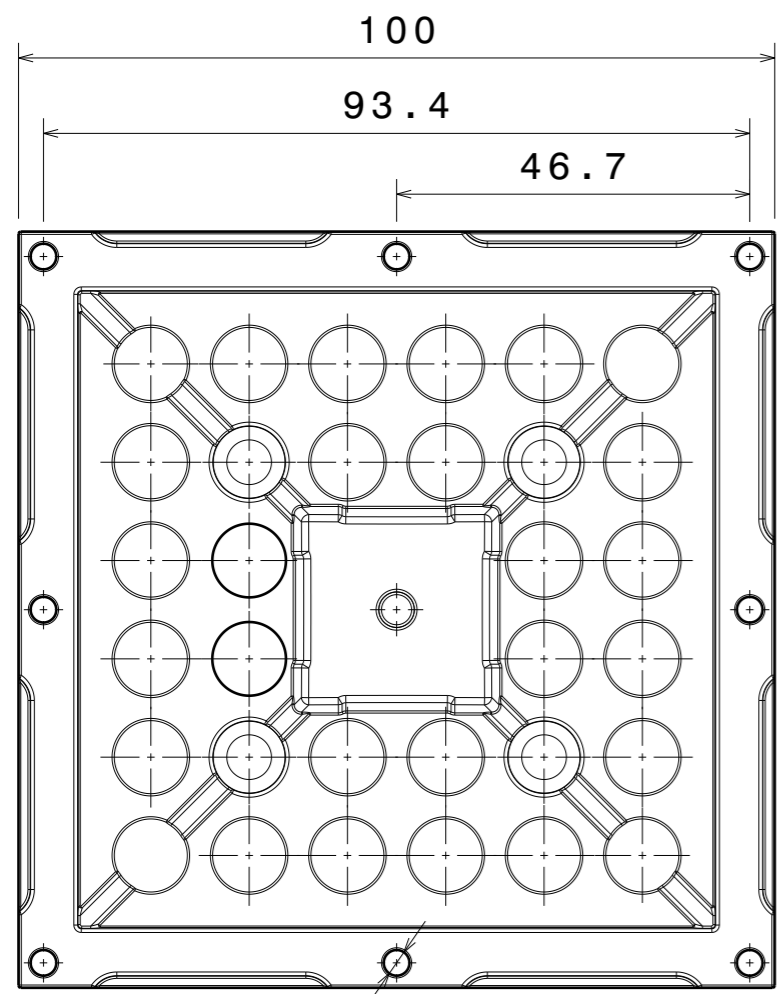

See Code table
Height (9.25)

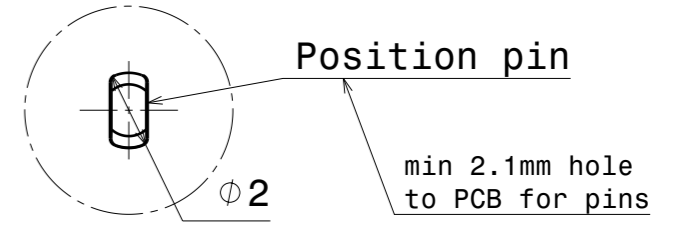
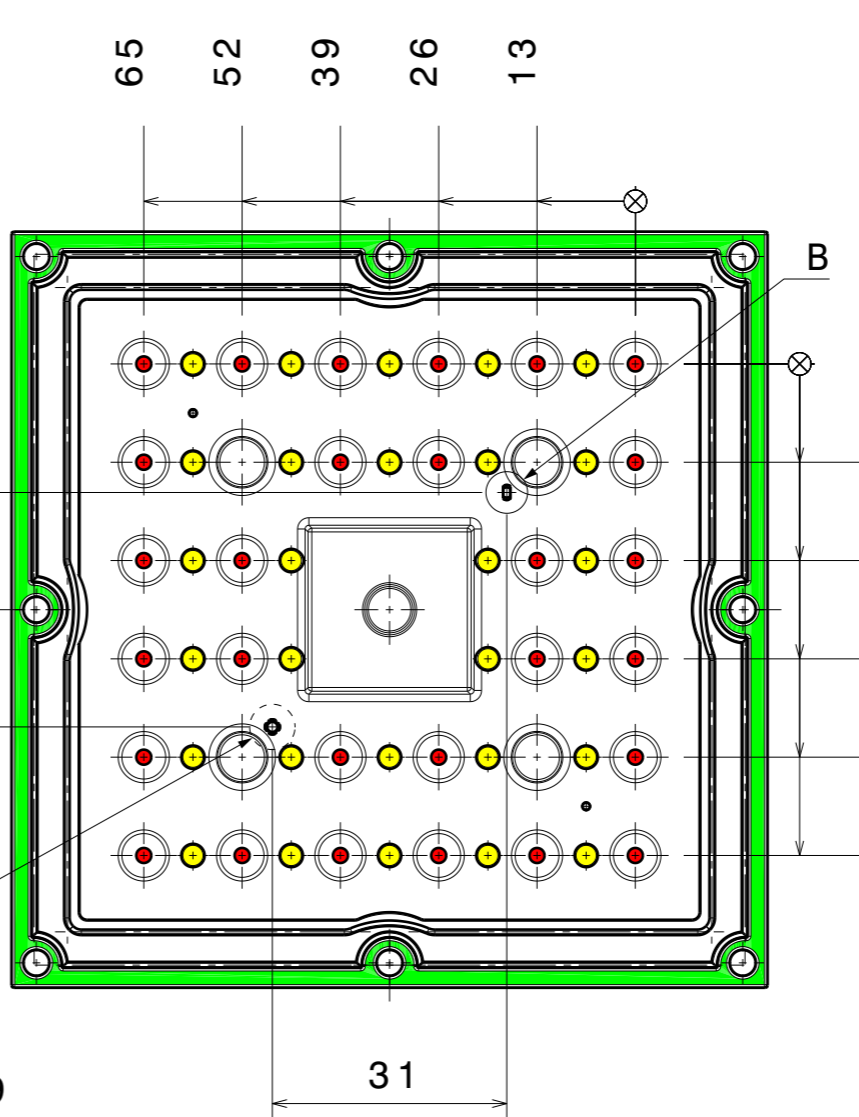
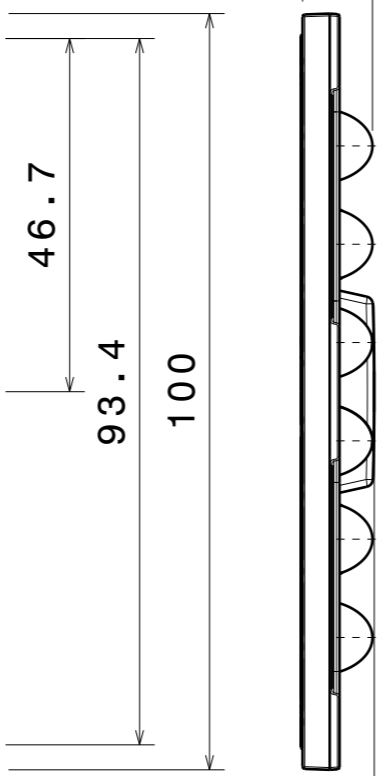

Detail B
Scale: 5:1

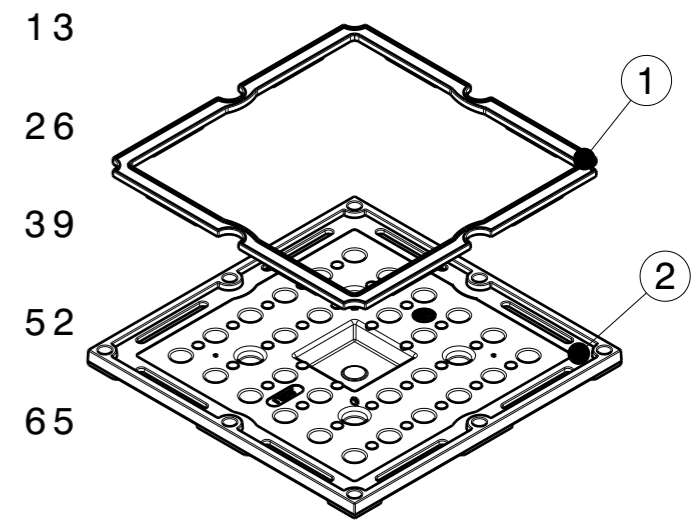

Isometric exploded view
Scale: 1:2

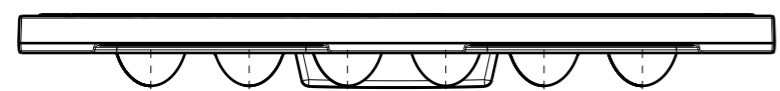

Light pattern direction

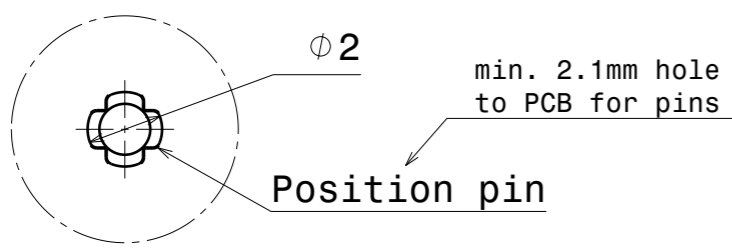
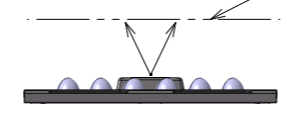

Detail A
Scale: 5:1

Light pattern direction

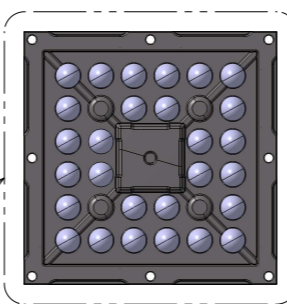

Code table:

Assembly code	Lens code	Name	Material	Height
CS16322	C16319	STRADELLA-IP-28-HB-S	PMMA	9.20mm
CS16323	C16320	STRADELLA-IP-28-HB-M	PMMA	8.57mm
CS16324	C16321	STRADELLA-IP-28-HB-W	PMMA	8.47mm
CS16328	C16325	STRADELLA-IP-28-HB-S-PC	PC	9.20mm
CS16329	C16326	STRADELLA-IP-28-HB-M-PC	PC	8.57mm
CS16330	C16327	STRADELLA-IP-28-HB-W-PC	PC	8.47mm

COMPONENTS

INDEX	PRODUCT	TYPE	MATERIAL	COLOUR
1	C15900_STRADELLA-28-SEAL	GASKET	SILICONE	white
2	See Code table	LENS	See code table	clear

MECHANICAL DRAWING

PRODUCT
STRADELLA-IP-28-HB-family



Tolerances if not otherwise shown
According to DIN ISO 2768-1
Linear measures:
Up to 30mm class M, otherwise class C.
According to DIN ISO 2768-2
Form and position: class L

FIRST ANGLE PROJECTION:

This drawing is the property of LEDiL Oy. It may not be reproduced, copied or communicated without a written agreement with LEDiL Oy.

SCALE	1:1	SIZE	A3	SHEET	1/2
-------	-----	------	----	-------	-----

- Notes**
- Heat Sink level
 - PCB level
 - Led location see red dot
- Ensure LED fitting, see our web site and/or 3D model for part detail.
See installation details page 2.

4

3

2

1

4

3

2

1

Holes for PCB fixing

STRADELLA-IP-28-SEAL

STRADELLA-IP-28-HB-family lens

Space for PCB fixing screw head

Space for connector

Position pin cutout

LED

MCPBC (for reference only)

See Notes for more details

LENS fixing:
 8pcs M3 screw recommended for fixing
 Use washer with screw if possible
 Use maximum tightening torque of 0.60Nm
 Countersunk screws not allowed

Notes

Please see more details for fastening in LEDiL Installation guide, www.ledil.com
 Seal is tested to work in LEDiL's test assemblies. Customer is recommended to test the sealing in the end product due many variables, such as heat sink surface and possible chemical traces.

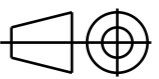
MECHANICAL DRAWING		LEDiL[®]	
PRODUCT STRADELLA-IP-28-HB-family			
Tolerances if not otherwise shown According to DIN ISO 2768-1 Linear measures: Up to 30mm class M, otherwise class C. According to DIN ISO 2768-2 Form and position: class L	FIRST ANGLE PROJECTION: 	This drawing is the property of LEDiL Oy. It may not be reproduced, copied or communicated without a written agreement with LEDiL Oy.	
SCALE	1:1	SIZE	A3
		SHEET	2/2

Valaisin: Ledil Oy CS16322_STRADELLA-IP-28-HB-S_(Cree XT-E)_SIMULATED
Lamput: 1 x Cree XT-E (100lm)

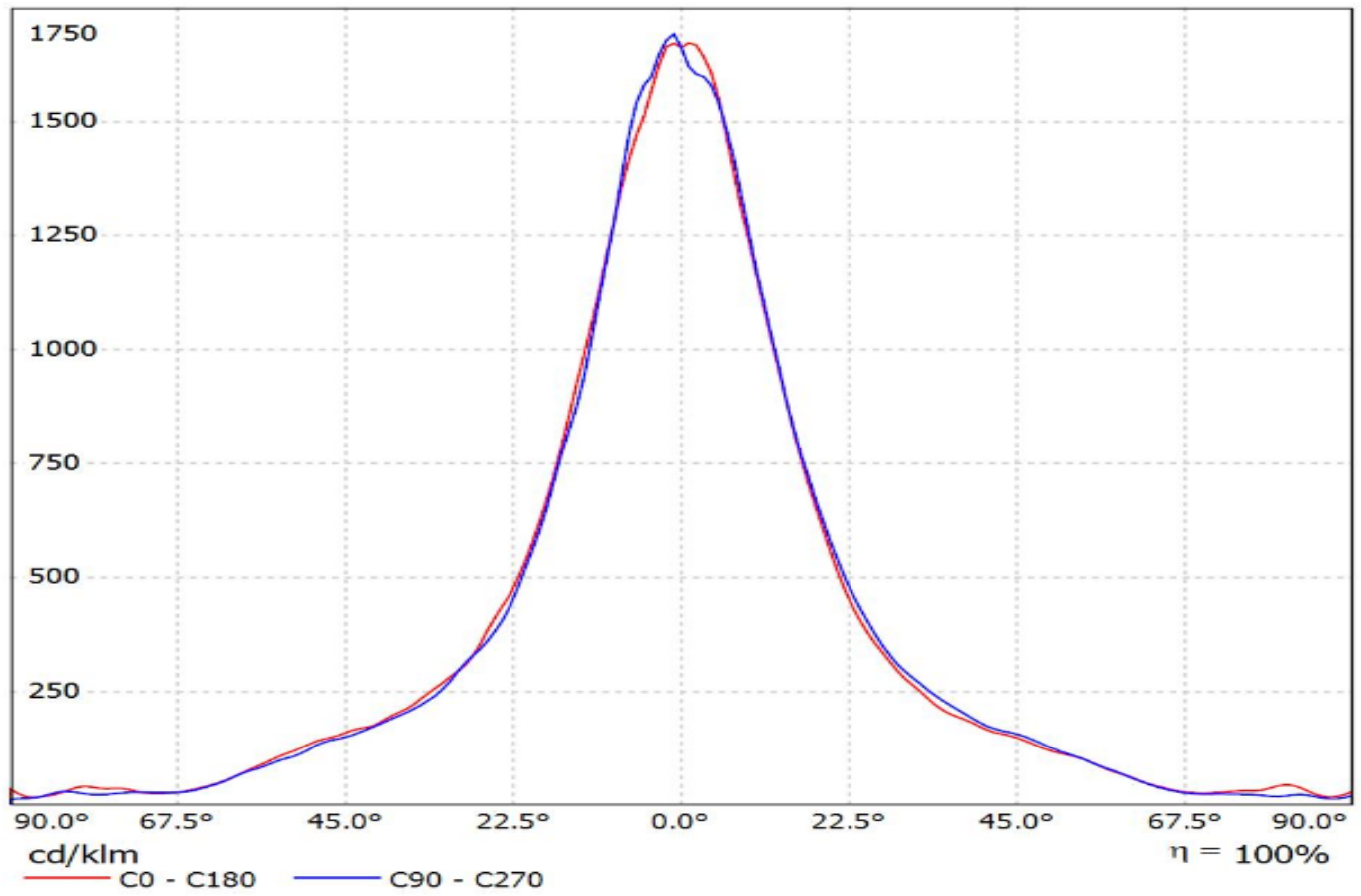

Luminaire: Ledil Oy CS16322_STRADELLA-IP-28-HB-S_(XP-G3)_SIMULATED
Lamps: 1 x Cree XP-G3

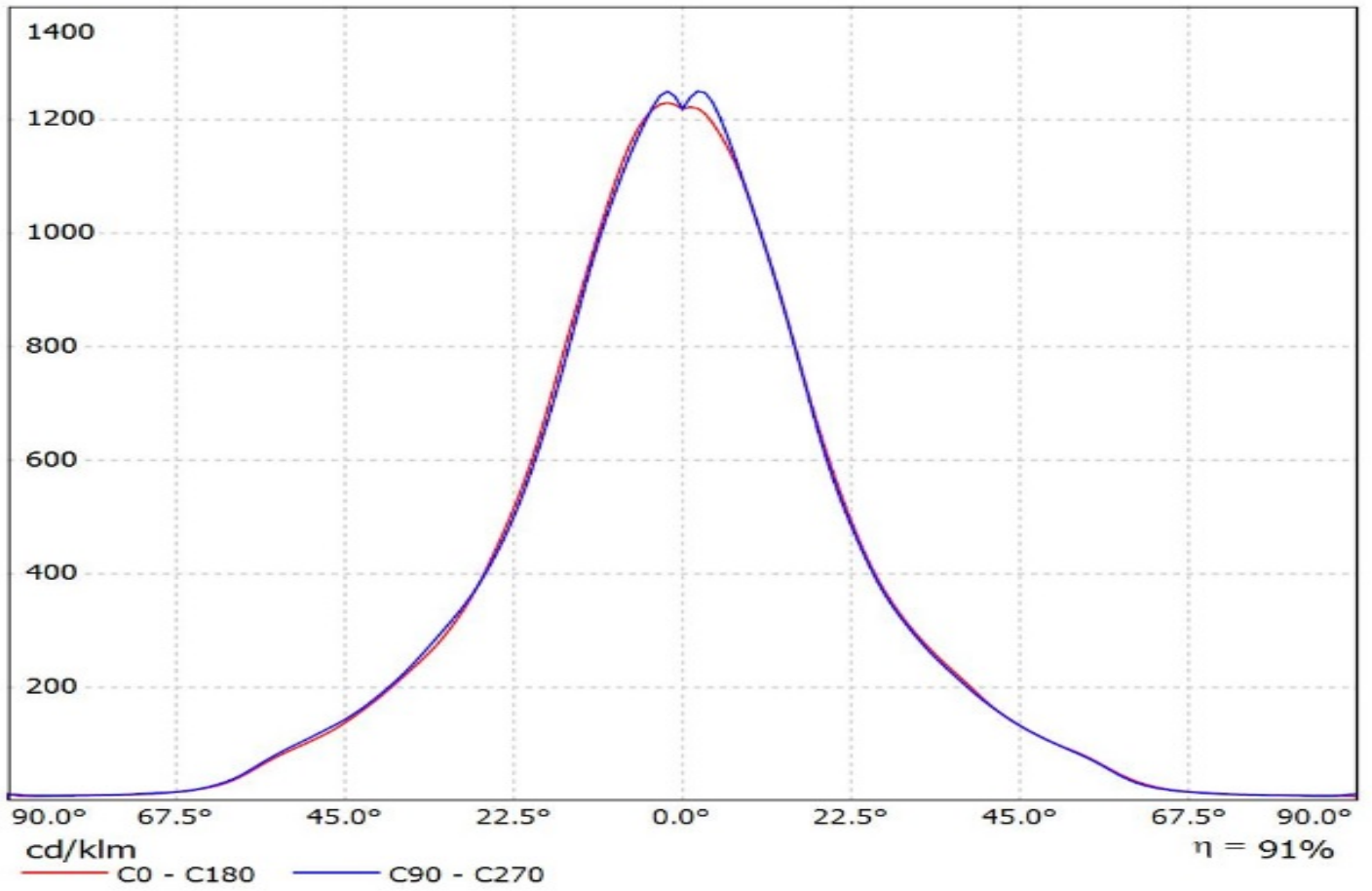

Valaisin: Ledil Oy CS16322_STRADELLA-IP-28-HB-S_(Luxeon 3030 2D)_SIMULATED
Lamput: 1 x LUXEON 3030 2D (100lm)

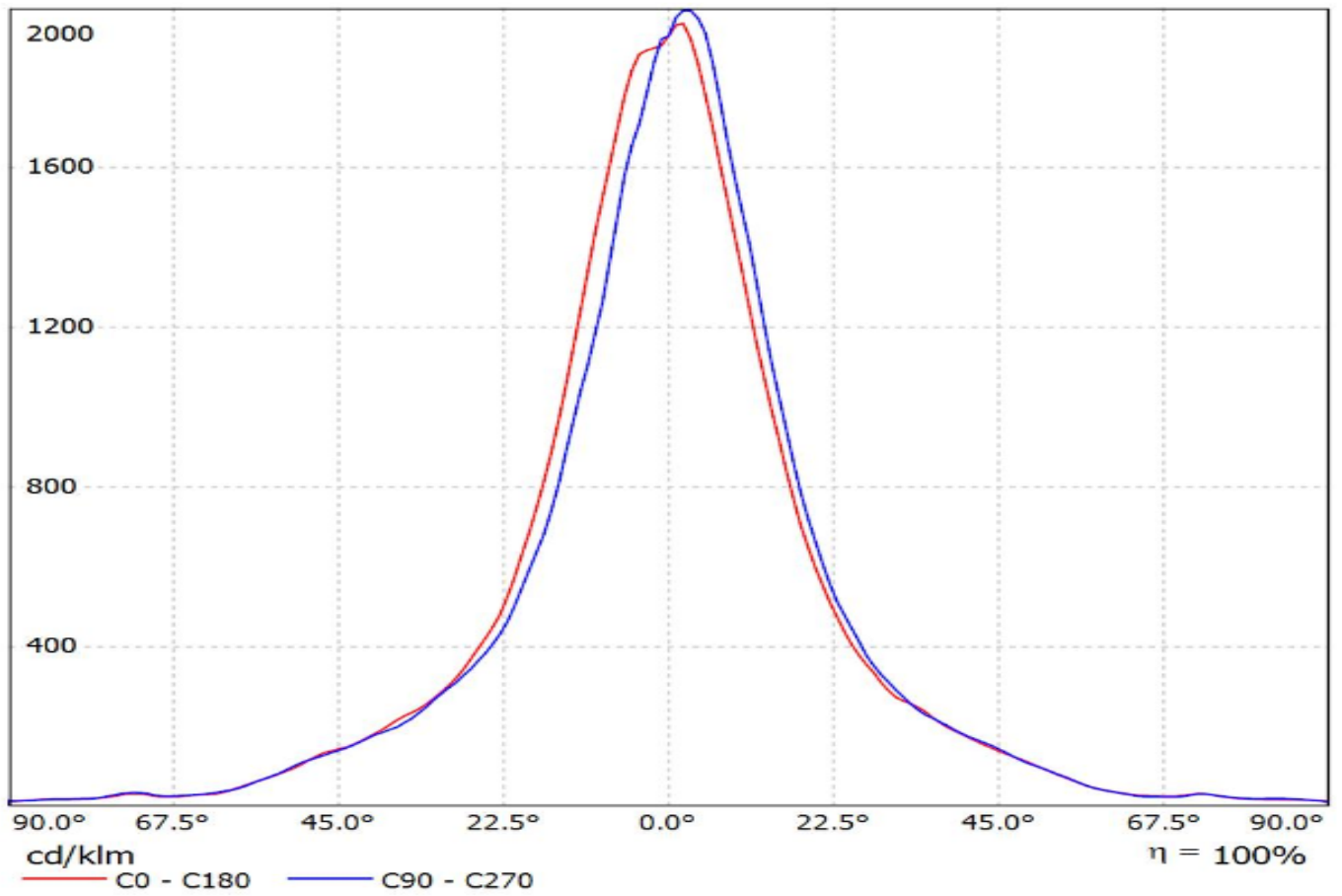

Valaisin: Ledil Oy CS16322_STRADELLA-IP-28-HB-S_(Nichia NVSLE21A)_SIMULATED
Lamput: 1 x Nichia NVSLE21A (100lm)

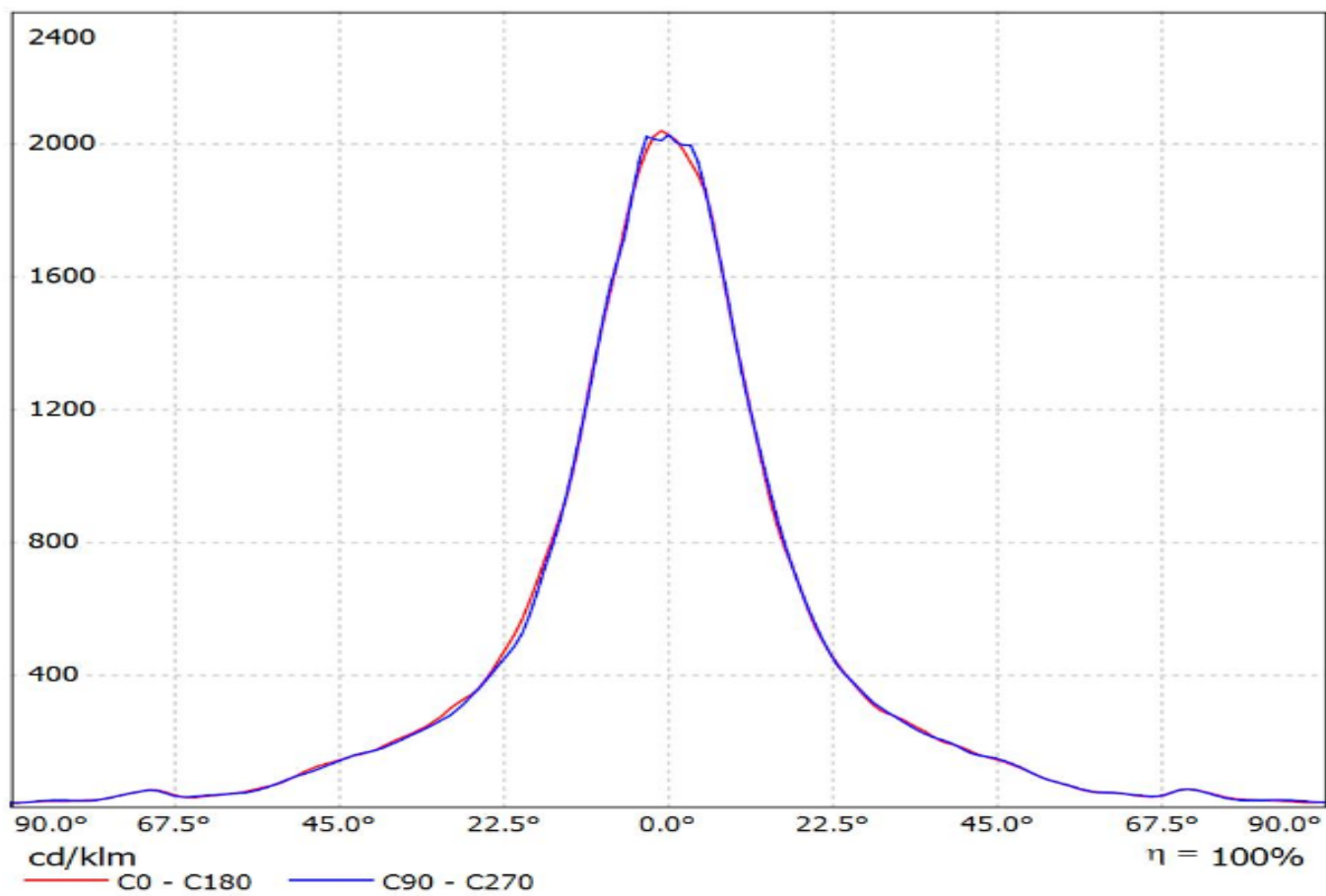

Luminaire: Ledil Oy CS16322_STRADELLA-IP-28-HB-S_SIMULATED
Lamps: 1 x SAMSUNG_LH351B

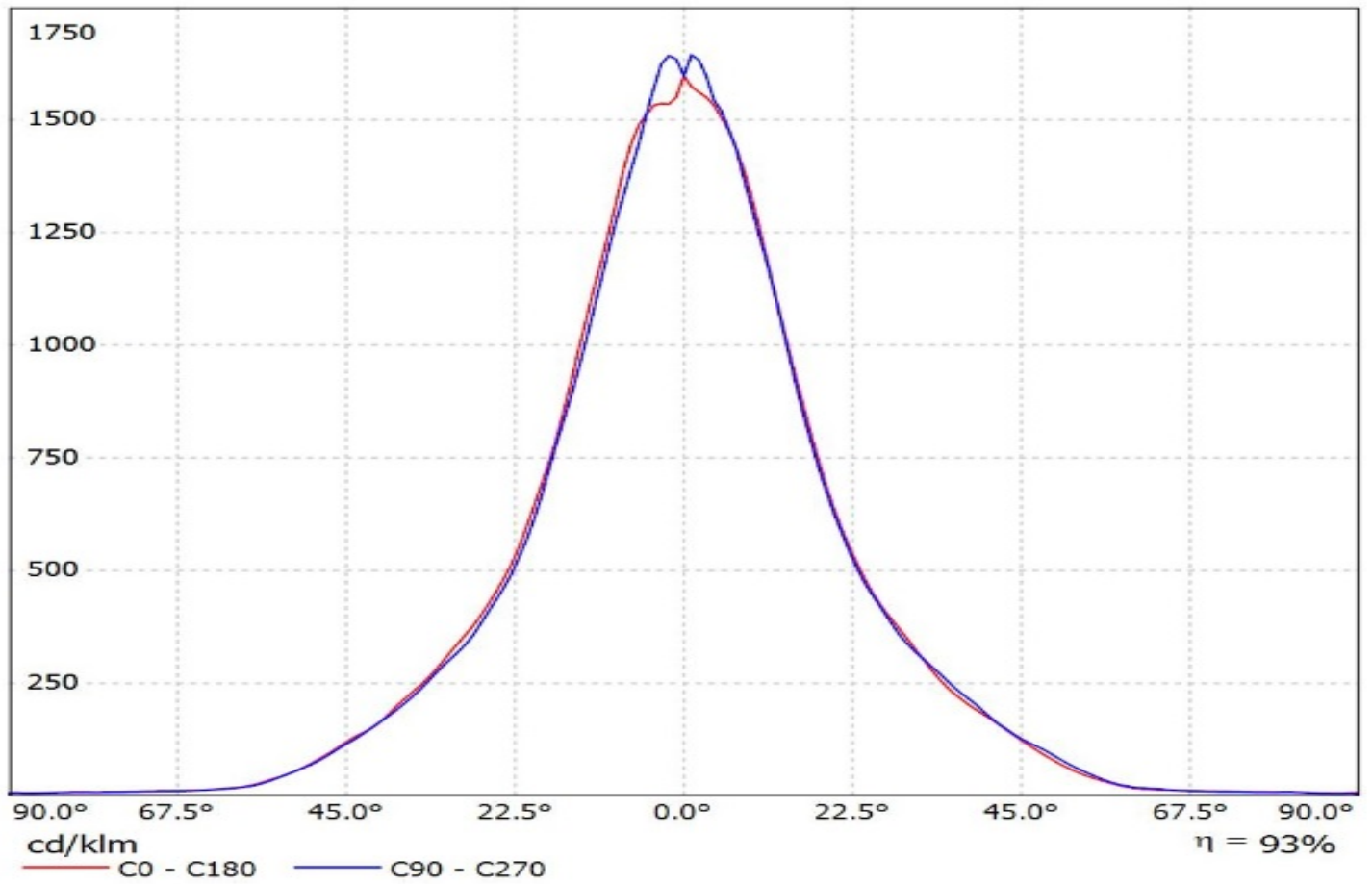

Luminaire: Ledil Oy CS16322_STRADELLA-IP-28-HB-S_SIMULATED
Lamps: 1 x SAMSUNG_LH351C

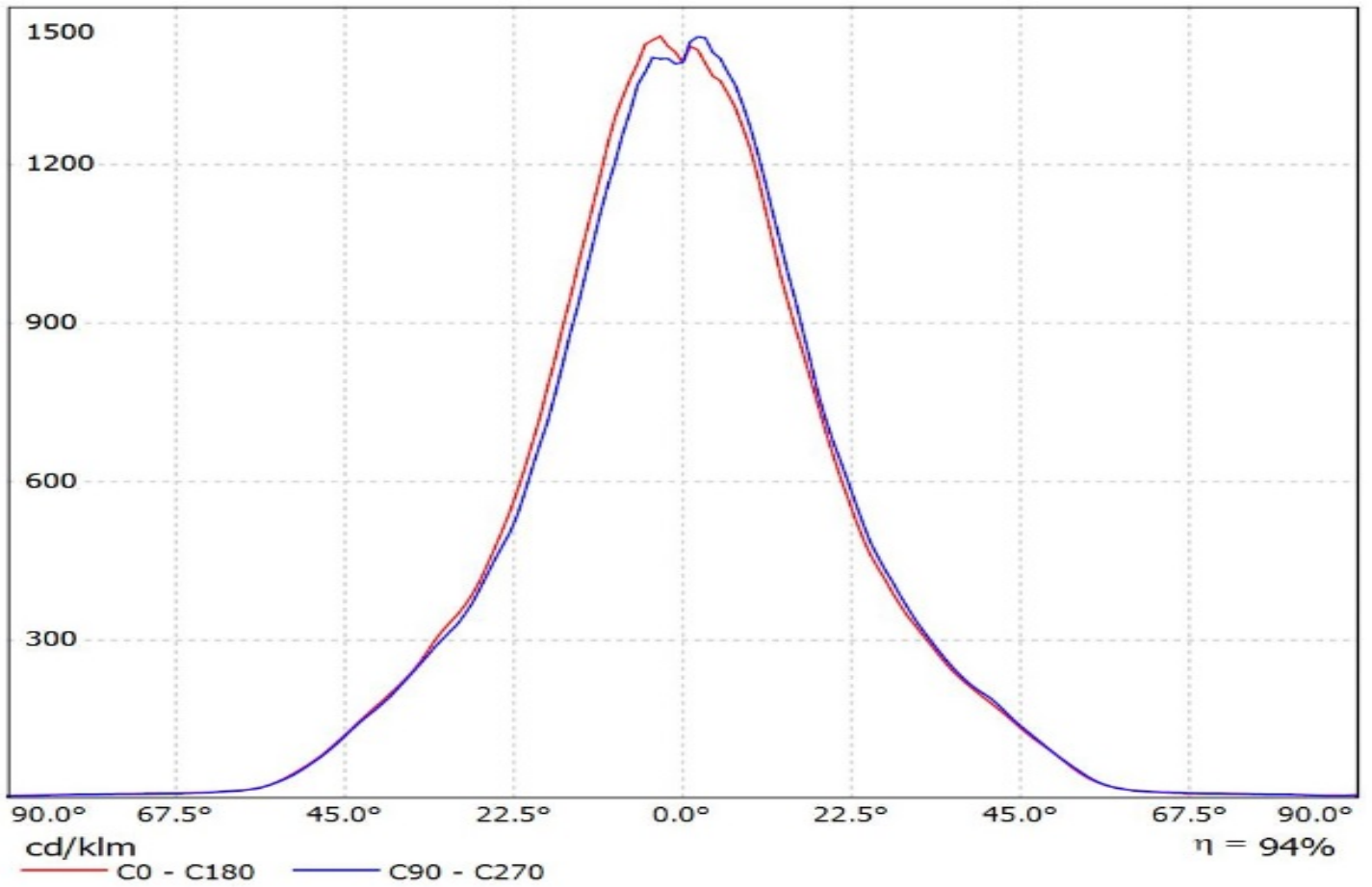

Valaisin: Ledil Oy CS16322_STRADELLA-IP-28-HB-S_(Seoul Z8Y22)_SIMULATED
Lamput: 1 x Seoul Z8Y22 (100lm)

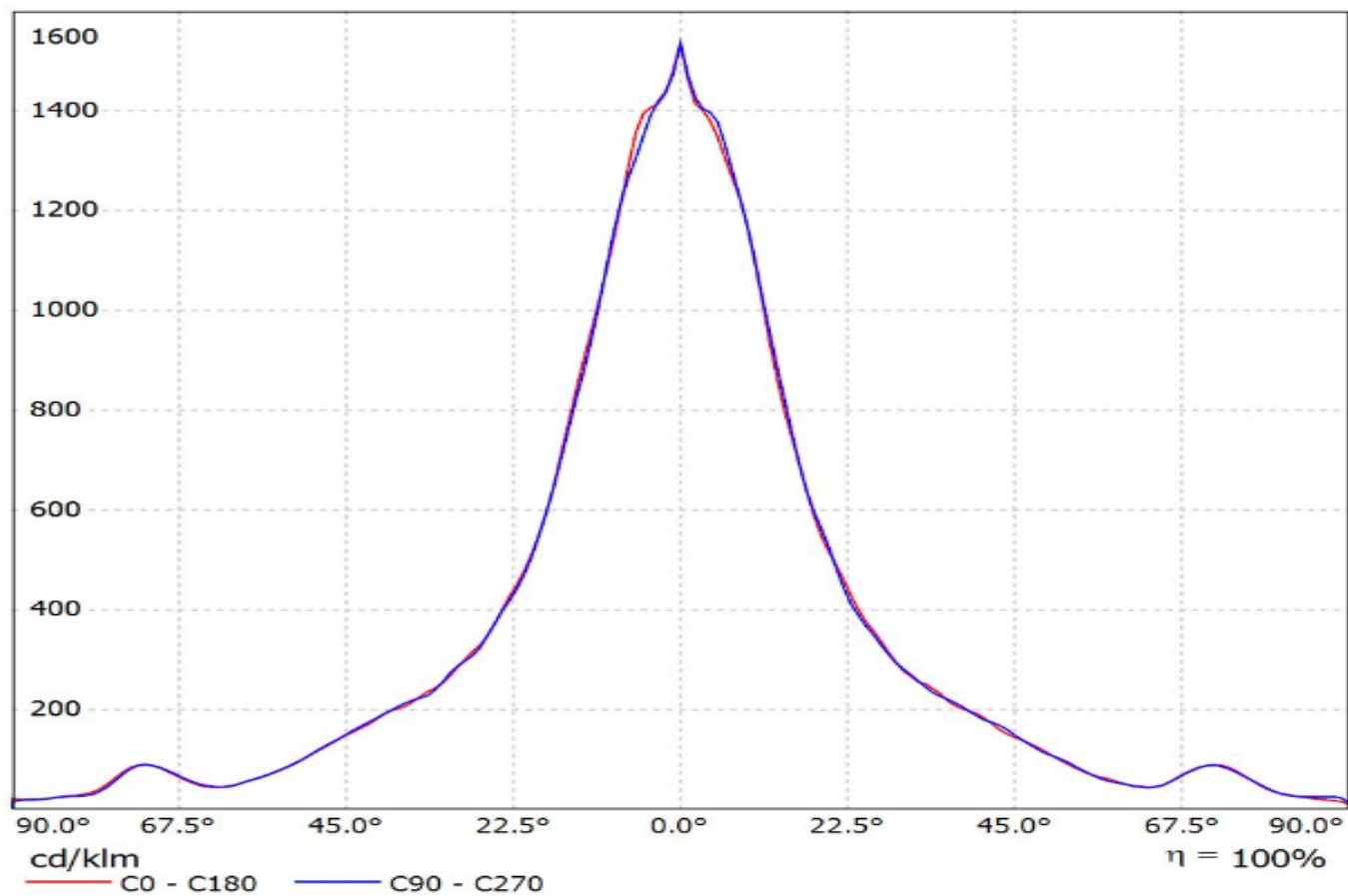

Valaisin: Ledil Oy CS16322_STRADELLA-IP-28-HB-S_(Cree XT-E)_SIMULATED
Lamput: 1 x Cree XT-E (100lm)

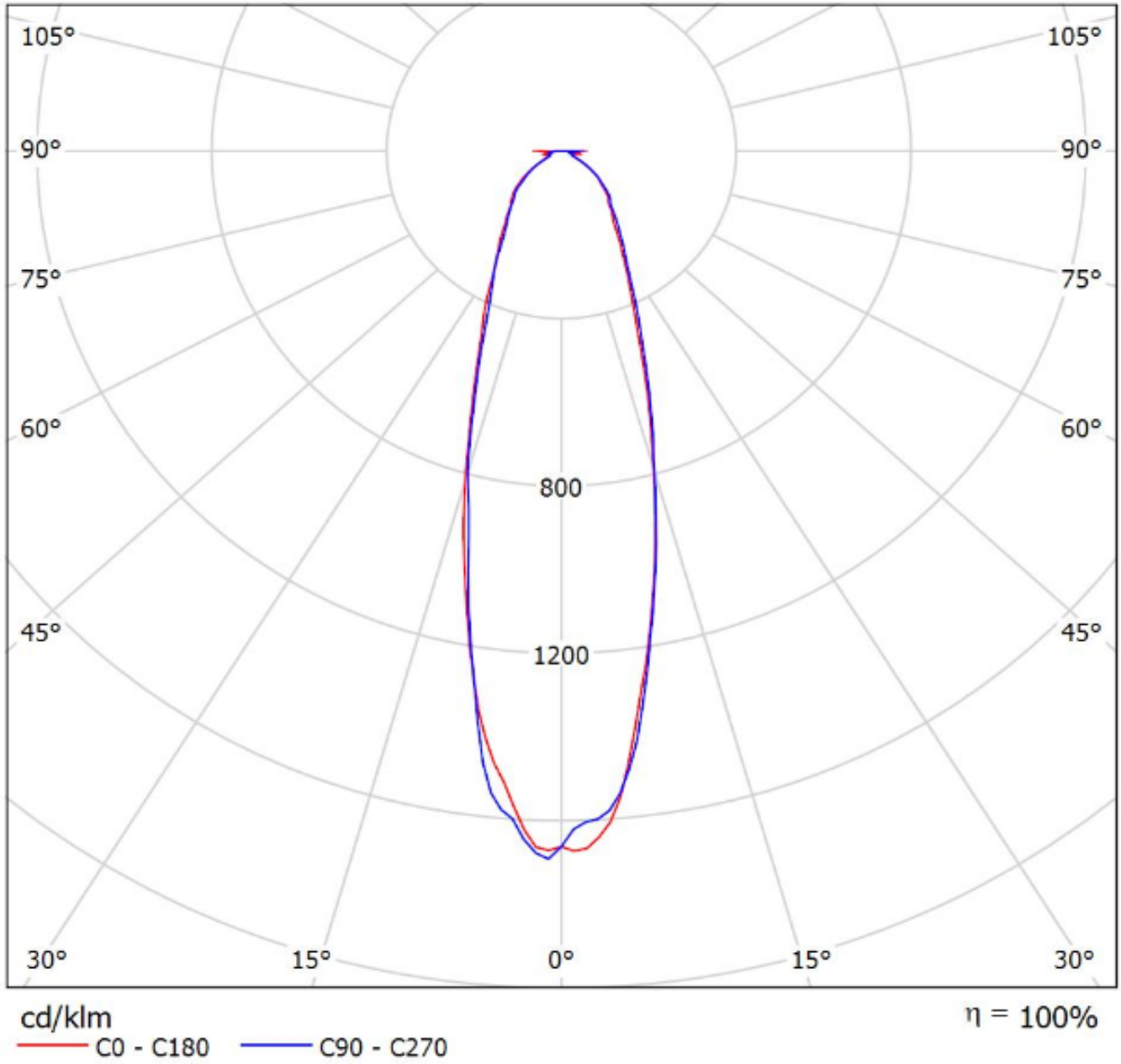

Luminaire: Ledil Oy CS16322_STRADELLA-IP-28-HB-S_(XP-G3)_SIMULATED
Lamps: 1 x Cree XP-G3

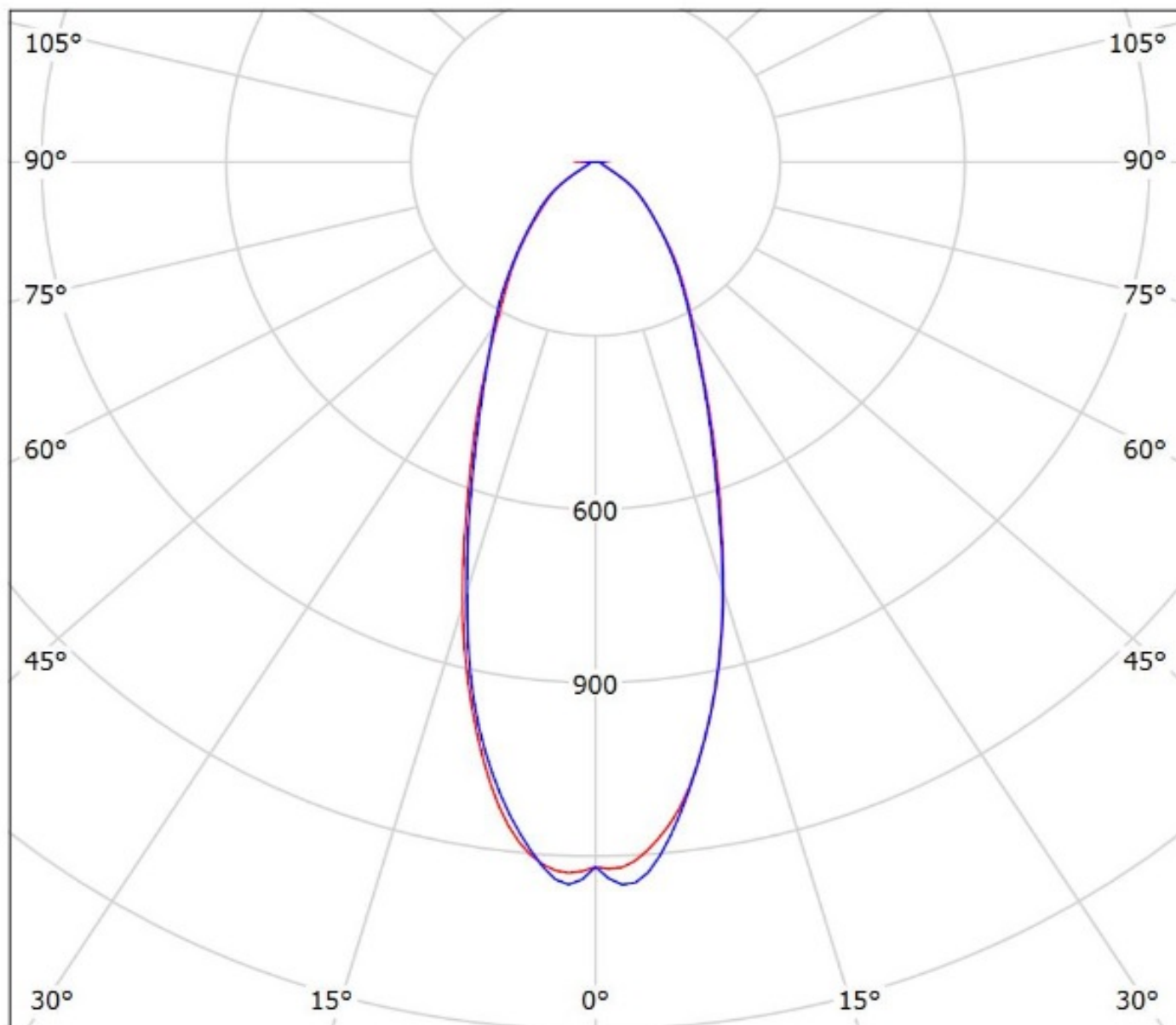

cd/klm

— C0 - C180 — C90 - C270

$\eta = 91\%$

Valaisin: Ledil Oy CS16322_STRADELLA-IP-28-HB-S_(Luxeon 3030 2D)_SIMULATED
Lamput: 1 x LUXEON 3030 2D (100lm)

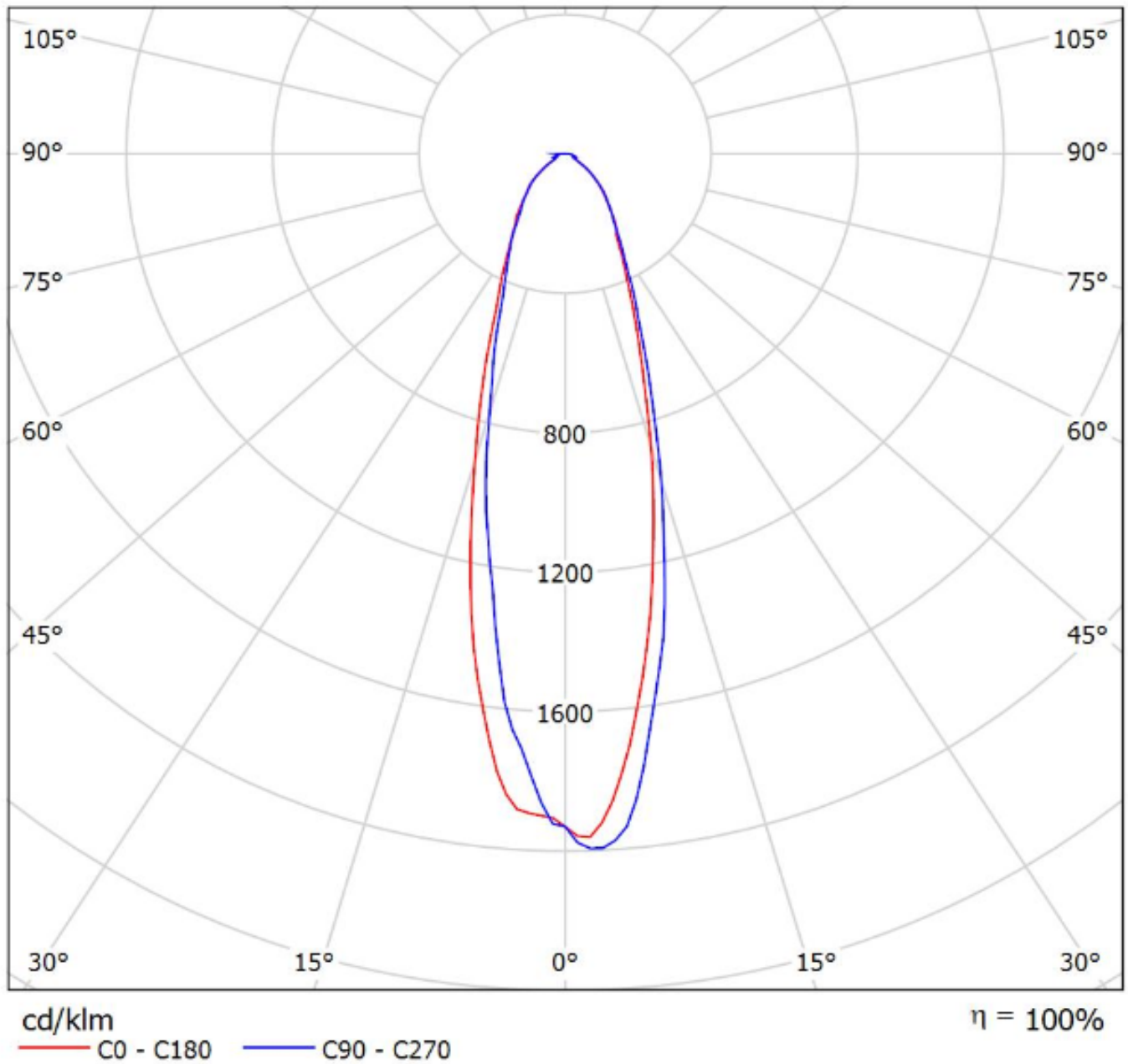

Valaisin: Ledil Oy CS16322_STRADELLA-IP-28-HB-S_(Nichia NVSLE21A)_SIMULATED
Lamput: 1 x Nichia NVSLE21A (100lm)

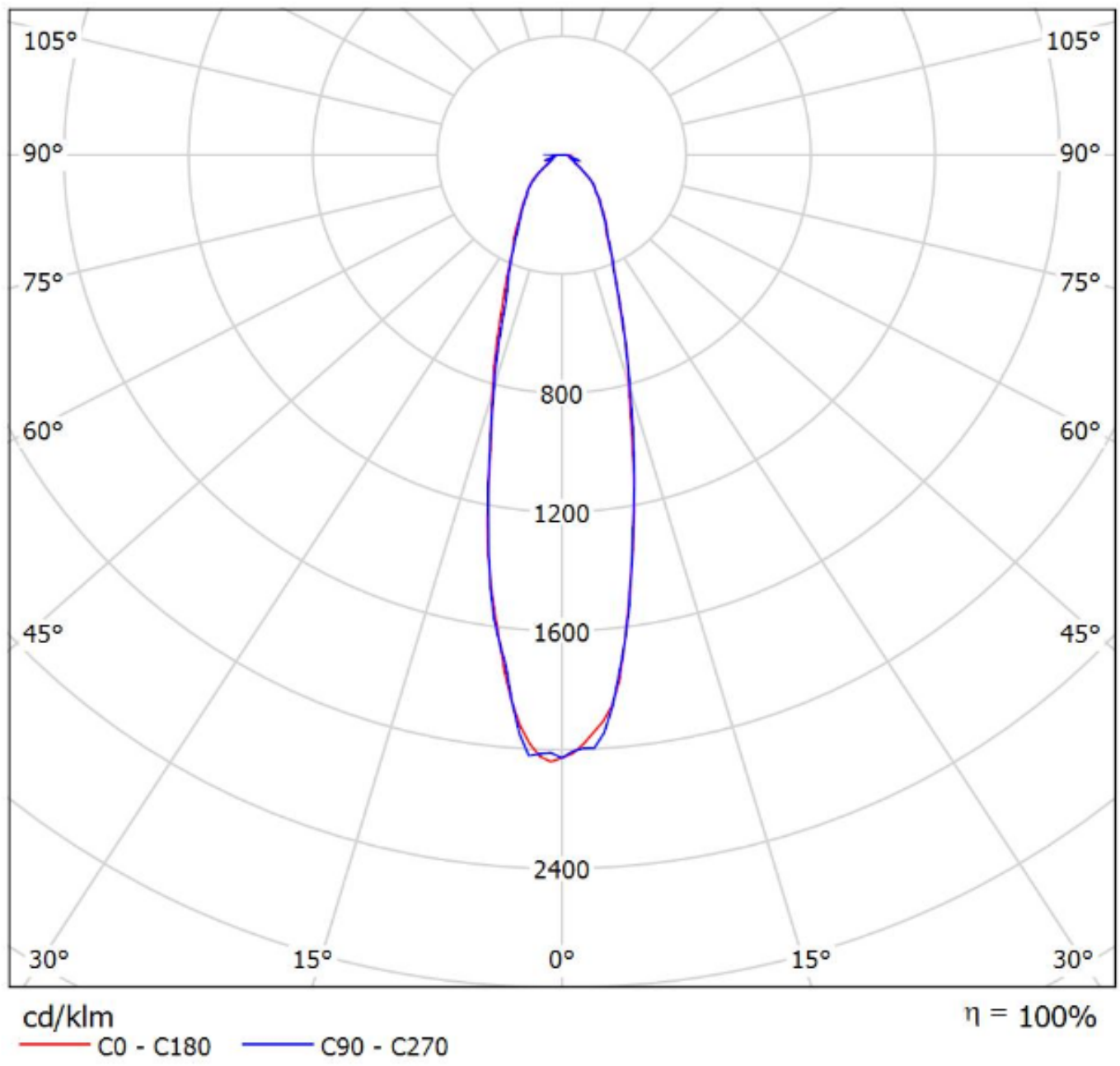

Luminaire: Ledil Oy CS16322_STRADELLA-IP-28-HB-S_SIMULATED
Lamps: 1 x SAMSUNG_LH351B

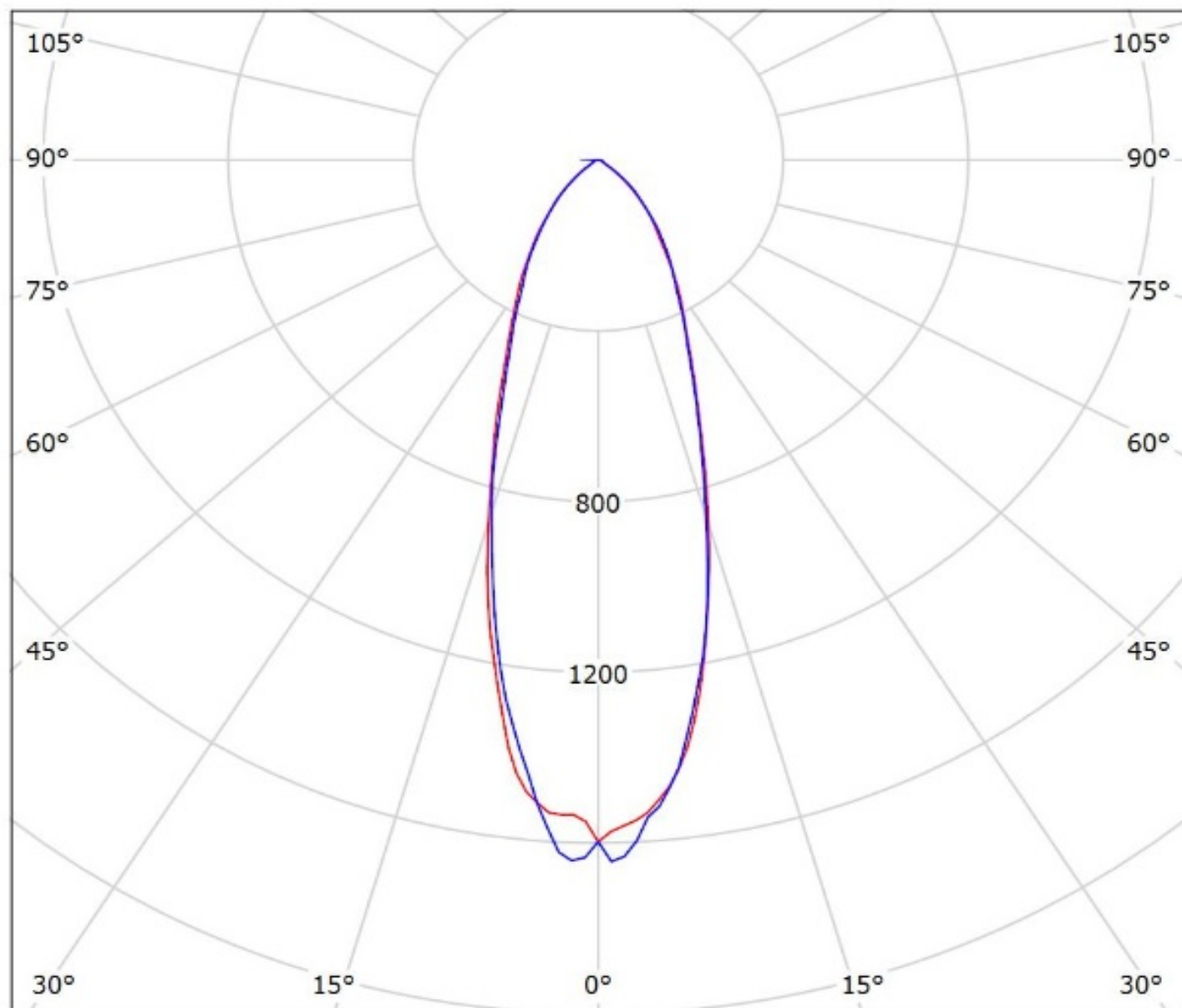

cd/klm

— C0 - C180 — C90 - C270

$\eta = 93\%$

Luminaire: Ledil Oy CS16322_STRADELLA-IP-28-HB-S_SIMULATED
Lamps: 1 x SAMSUNG_LH351C

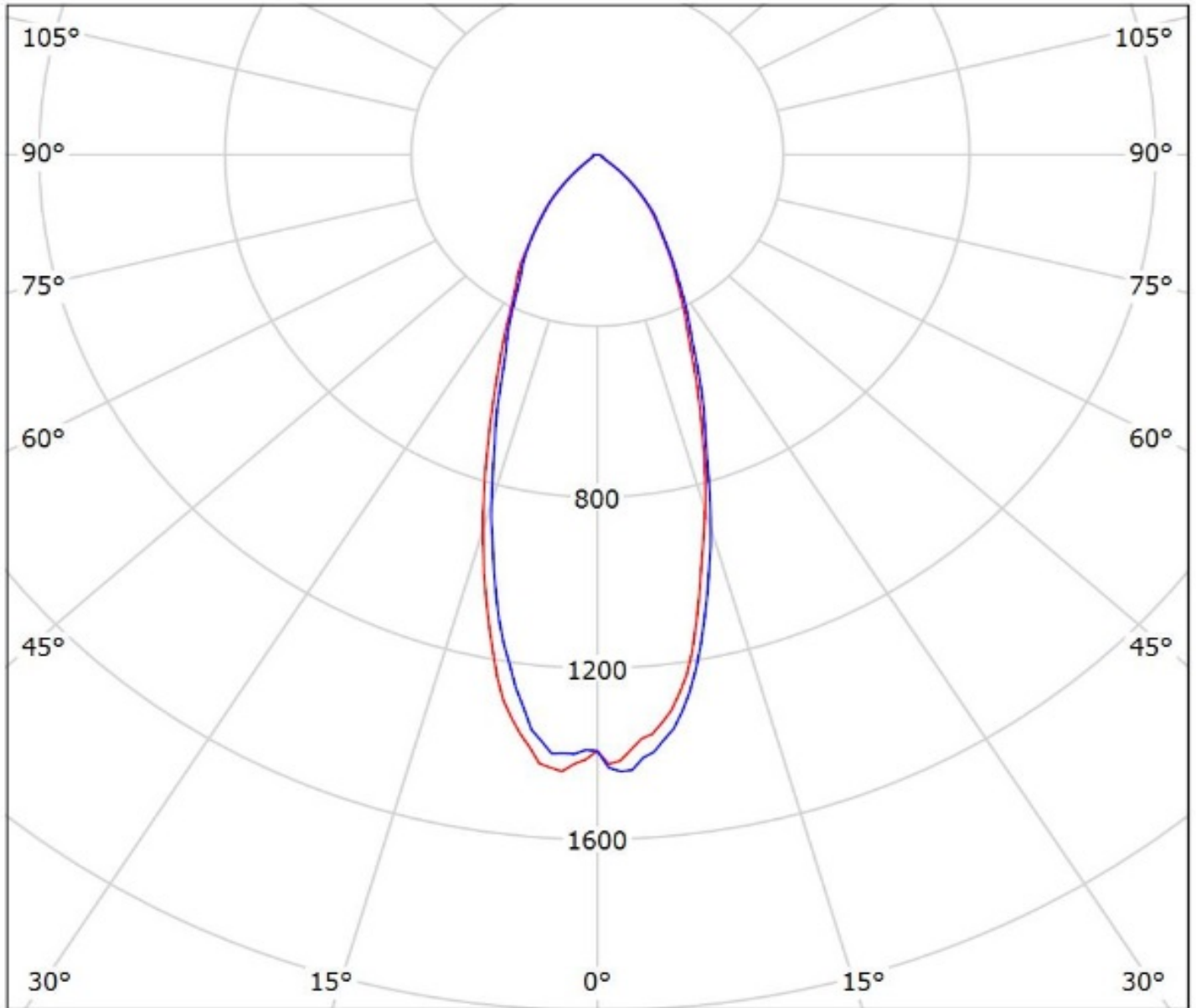

cd/klm

— C0 - C180 — C90 - C270

$\eta = 94\%$

Valaisin: Ledil Oy CS16322_STRADELLA-IP-28-HB-S_(Seoul Z8Y22)_SIMULATED
Lamput: 1 x Seoul Z8Y22 (100lm)

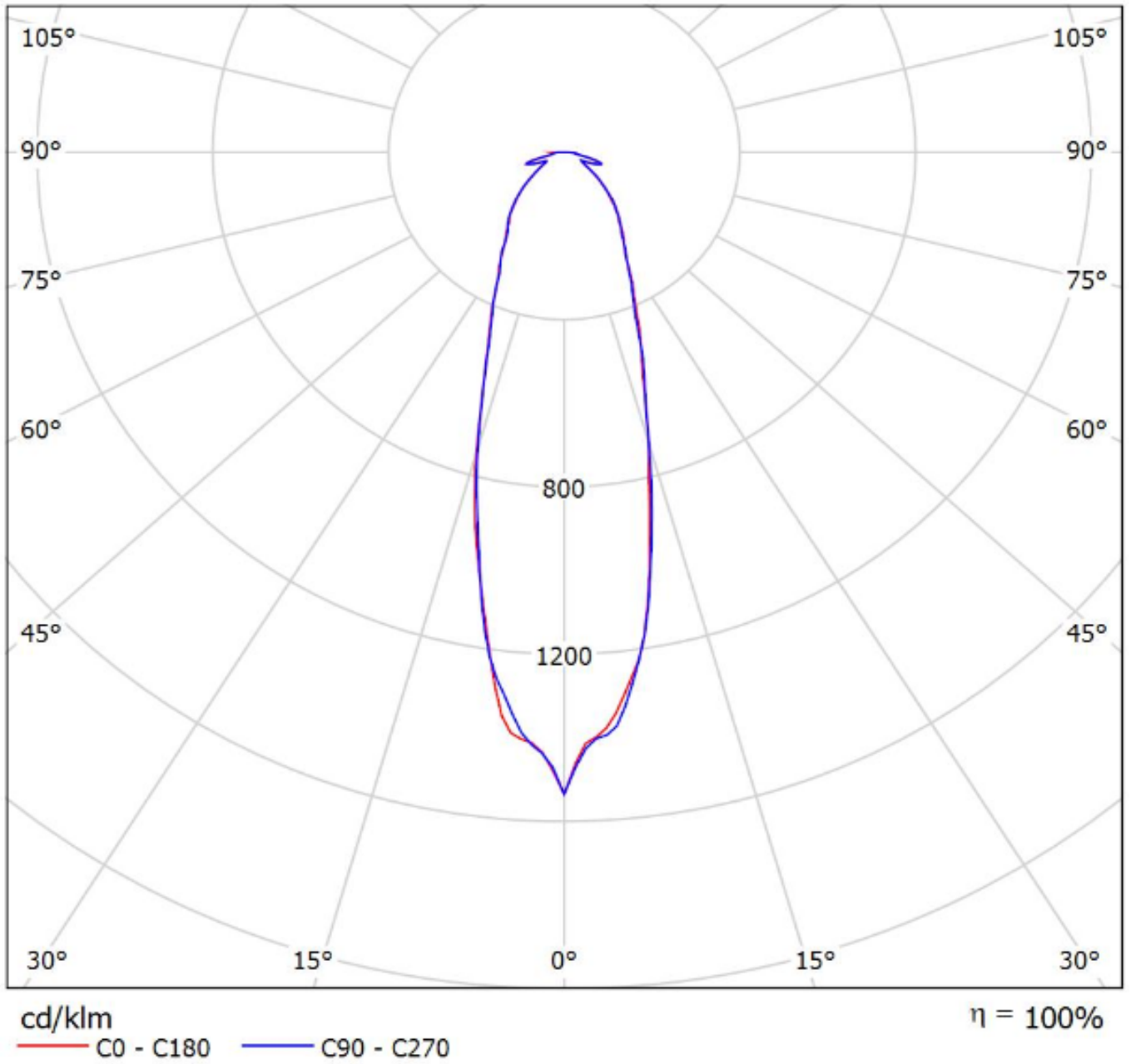

NOTE: The typical divergence will be changed by different color, chip size and chip position tolerance. The typical total divergence is the full angle measured where the luminous intensity is half of the peak value.