



PRODUCT DATASHEET

Stradella series

last update 11/12/2017

DETAILS

Product Number	CS16102_STRADELLA-IP-28-T3
Family	Stradella
Type	Lens
Color	clear
Diameter	100 x 100 mm
Height	mm
Style	square
Optic Material	PMMA
Holder Material	
Fastening	pin, screw
Status	production ready
ROHS Compliant	Yes
Date Updated	11/12/2017



OPTICAL PROPERTIES

LED	Viewing Angle	Light Beam	Efficiency	cd/lm	Connector
XT-E	Asymmetric deg	Streetligh...	94 %	0.600	-
XP-G3	sim: Asymmetric	Streetligh...	sim: 90 %	sim: 0.400	-
LUXEON 3030 2D	Asymmetric deg	Streetligh...	94 %	0.780	-
Duris S5 (2 chip)	Asymmetric deg	Streetligh...	94 %	0.680	-

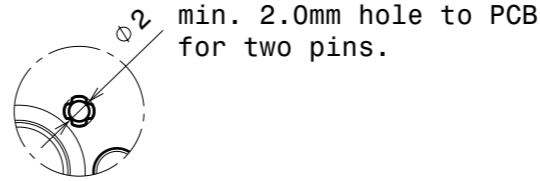
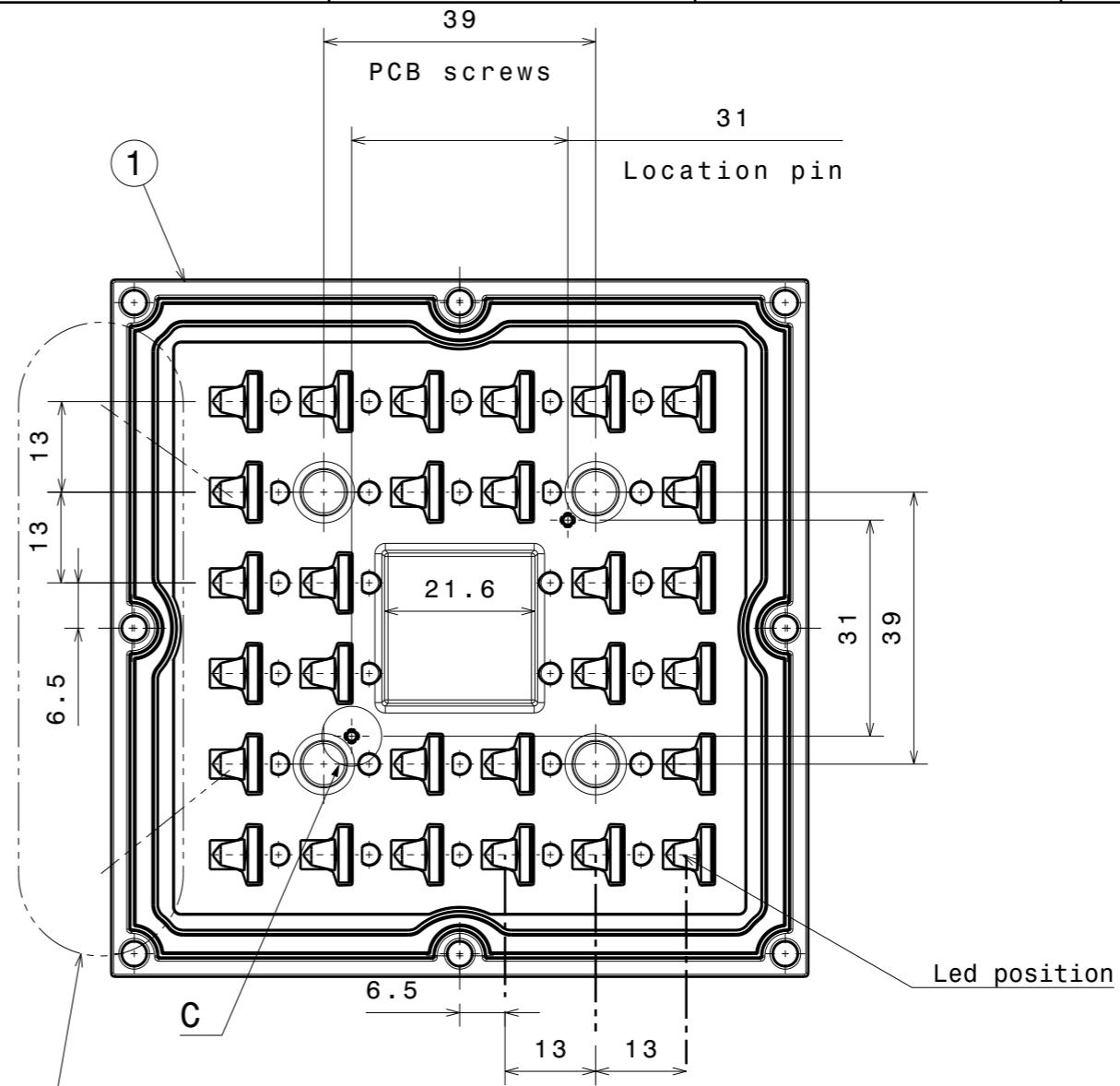
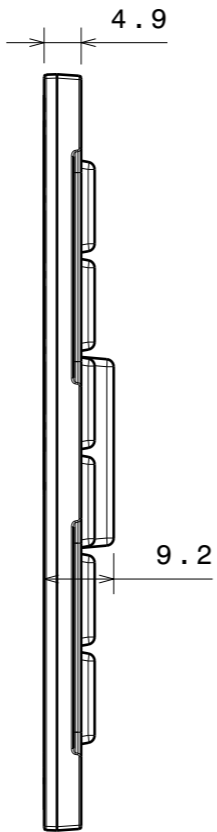
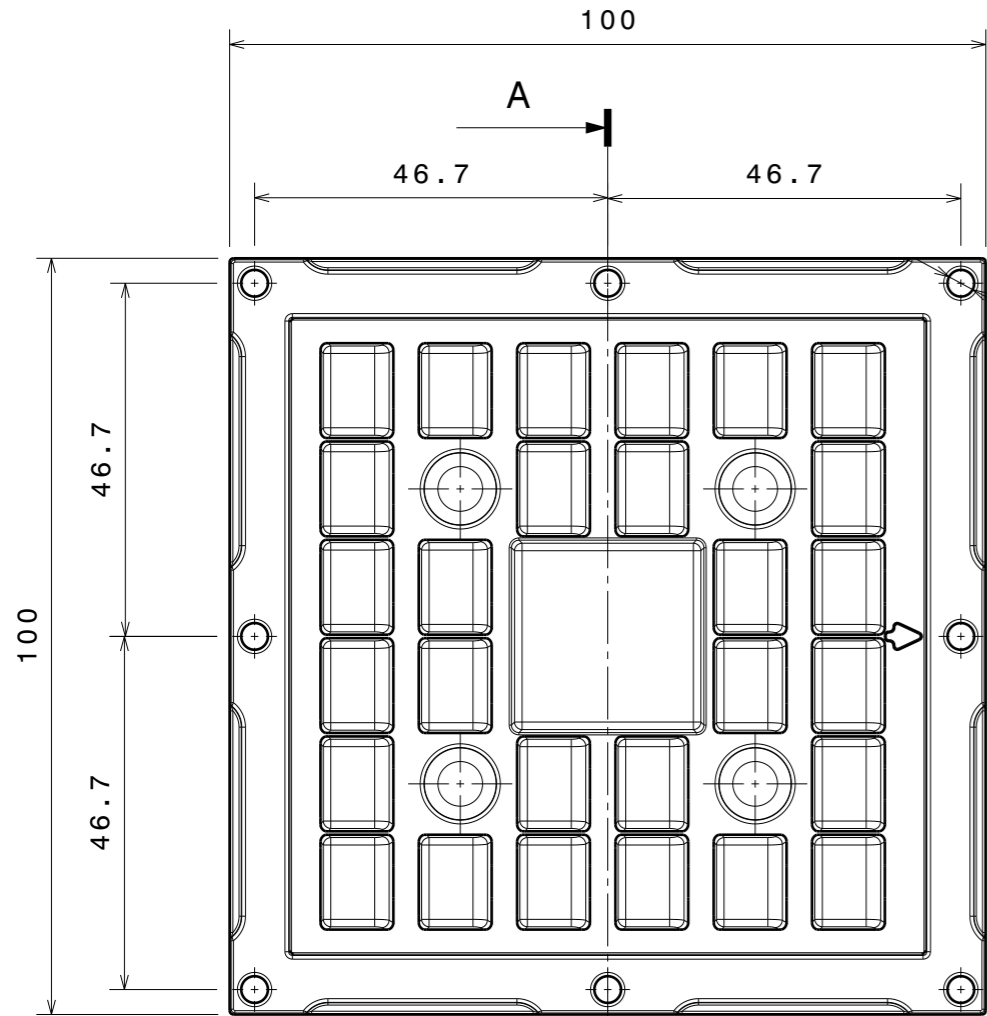

Detail C
Scale: 2:1

Beam direction

Typical space for component
5.8

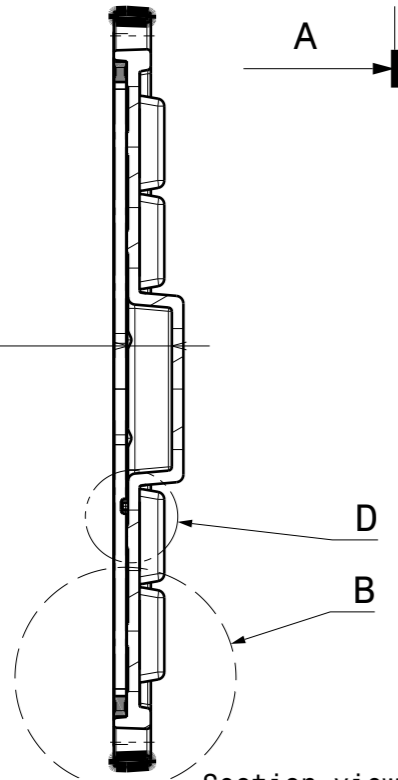

Section view A-A
Scale: 1:1

Detail D
Scale: 2:1

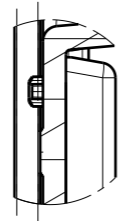

PCB space inside seal 81x 81mm

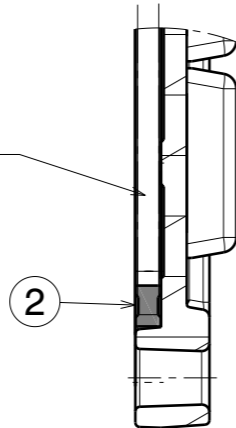

Detail B
Scale: 2:1

INDEX	PART NO	DESCRIPTION	MATERIAL	COLOUR
1	C16101	STRADELLA-IP-28-T3	PMMA	clear
2	C15900	STRADELLA-28-SEAL	Silicone	

Tolerances if not otherwise shown
According to DIN ISO 2768-1
Linear measures:
Up to 30mm class M, otherwise class C.
According to DIN ISO 2768-2
Form and position: class L

LEDiL

FIRST ANGLE PROJECTION:

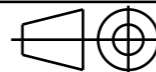

DRAWING TITLE

CS16102_STRADELLA-IP-28-T3

This drawing is the property of LEDiL Oy. It may not be reproduced, copied or communicated without a written agreement with LEDiL Oy.

SIZE PART NUMBER

A3

Mechanical Drawing

SCALE 1:1 WEIGHT

SHEET 1/1

Luminaire: Ledil CS16102_STRADELLA-IP-28-T3_(XT-E)

Lamps: 1 x Cree_XT-E_Stradella-28_1805.68lm@250mA_P=9.51344W_U=38.069V

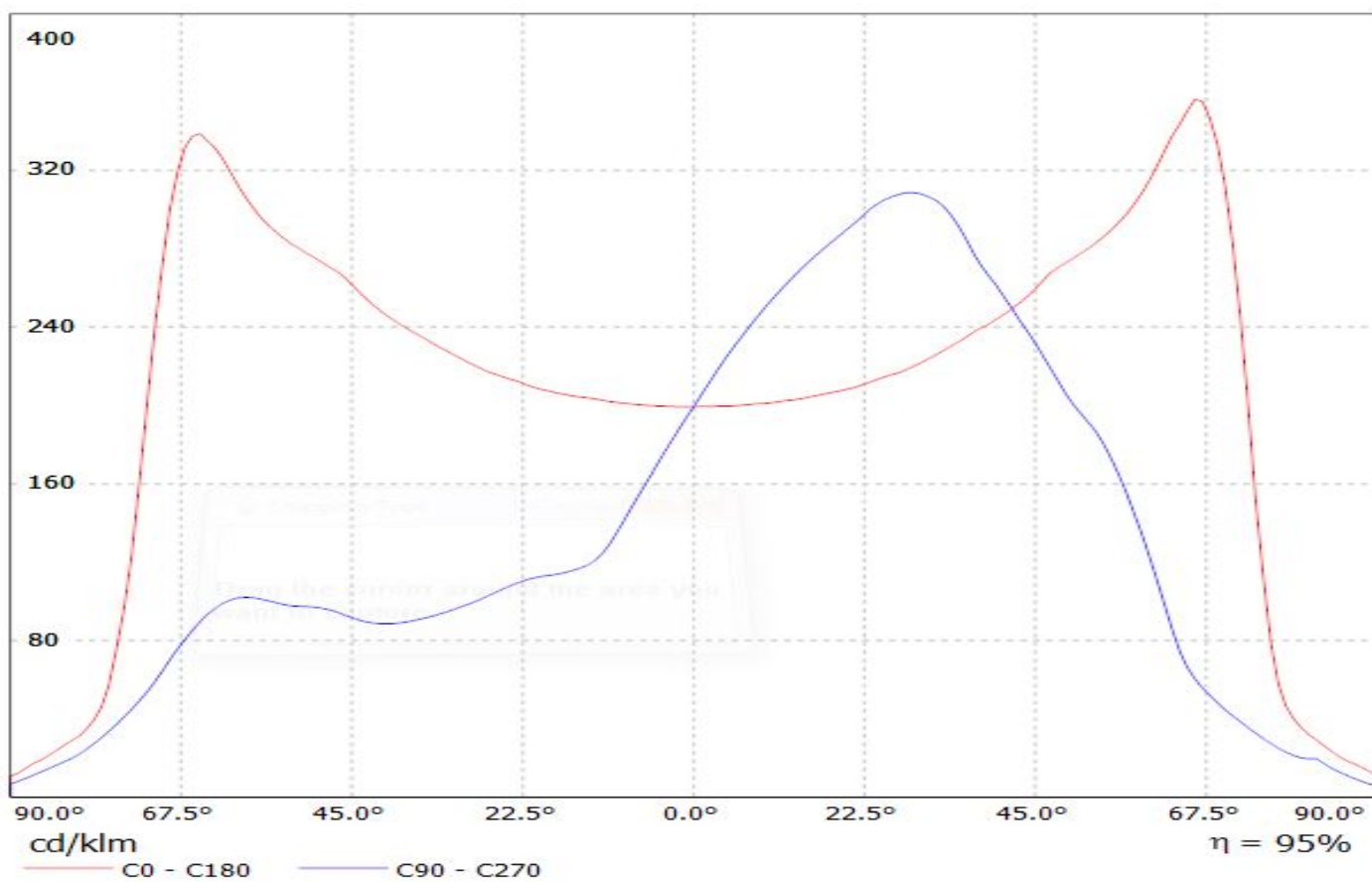

Luminaire: Ledil Oy CS16102_STRADELLA-IP-28-T3_(XP-G3)_SIMULATED
Lamps: 1 x Cree XP-G3

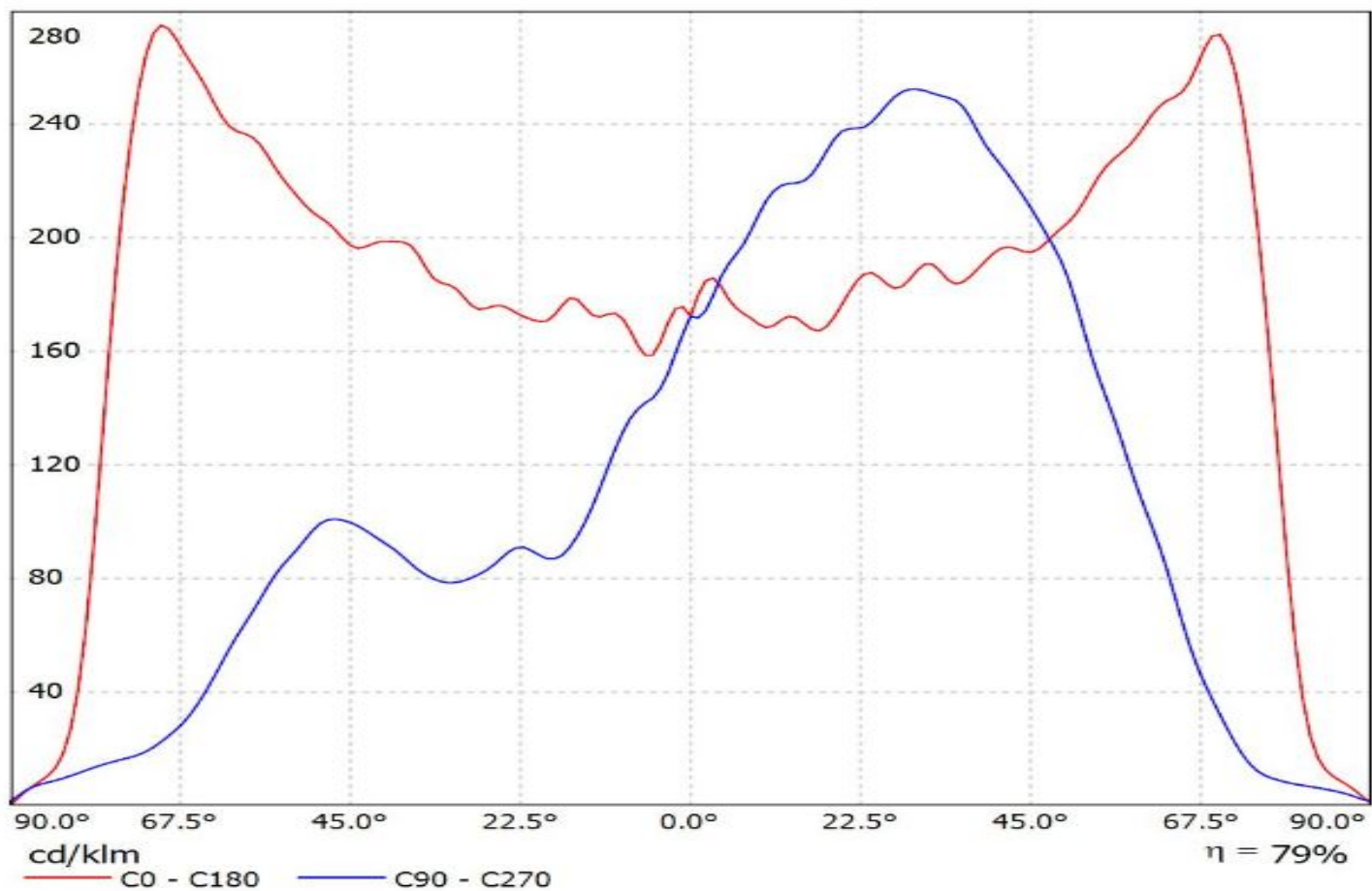

Luminaire: Ledil CS16102_STRADELLA-IP-28-T3_(Luxeon_3030_2D)

Lamps: 1 x Lumileds_Luxeon_3030_2D_1132.31lm@240mA_P=9.57624W_U=39.901V

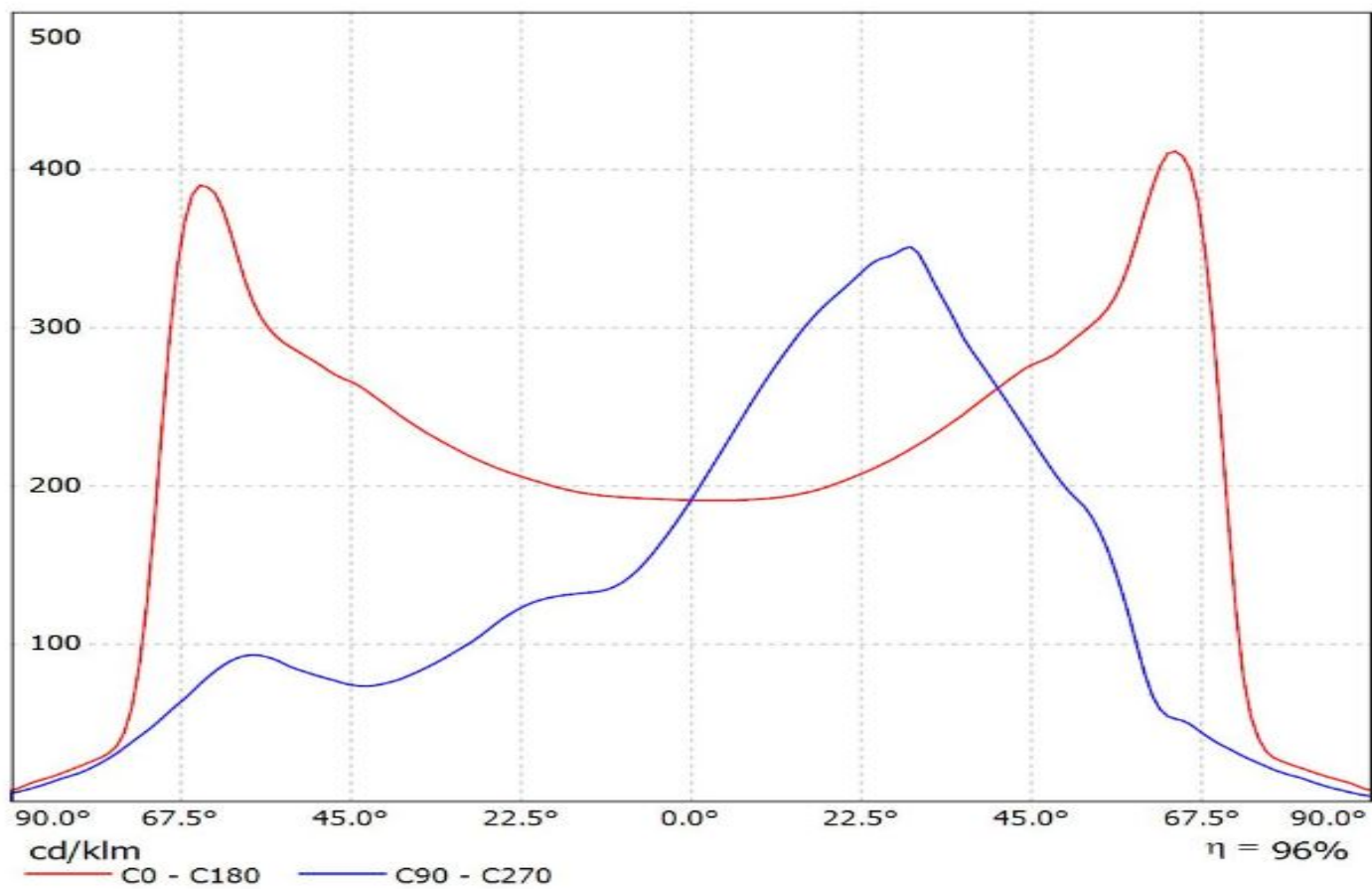

Luminaire: Ledil CS16102_STRADELLA-IP-28-T3_(Duris_S5)

Lamps: 1 x Osram_Duris_S5_Stradella28_(GW_PSLR32.EM-JQJS-A333-1)_786.457lm@250mA_P=4.90979W_η=0.250A

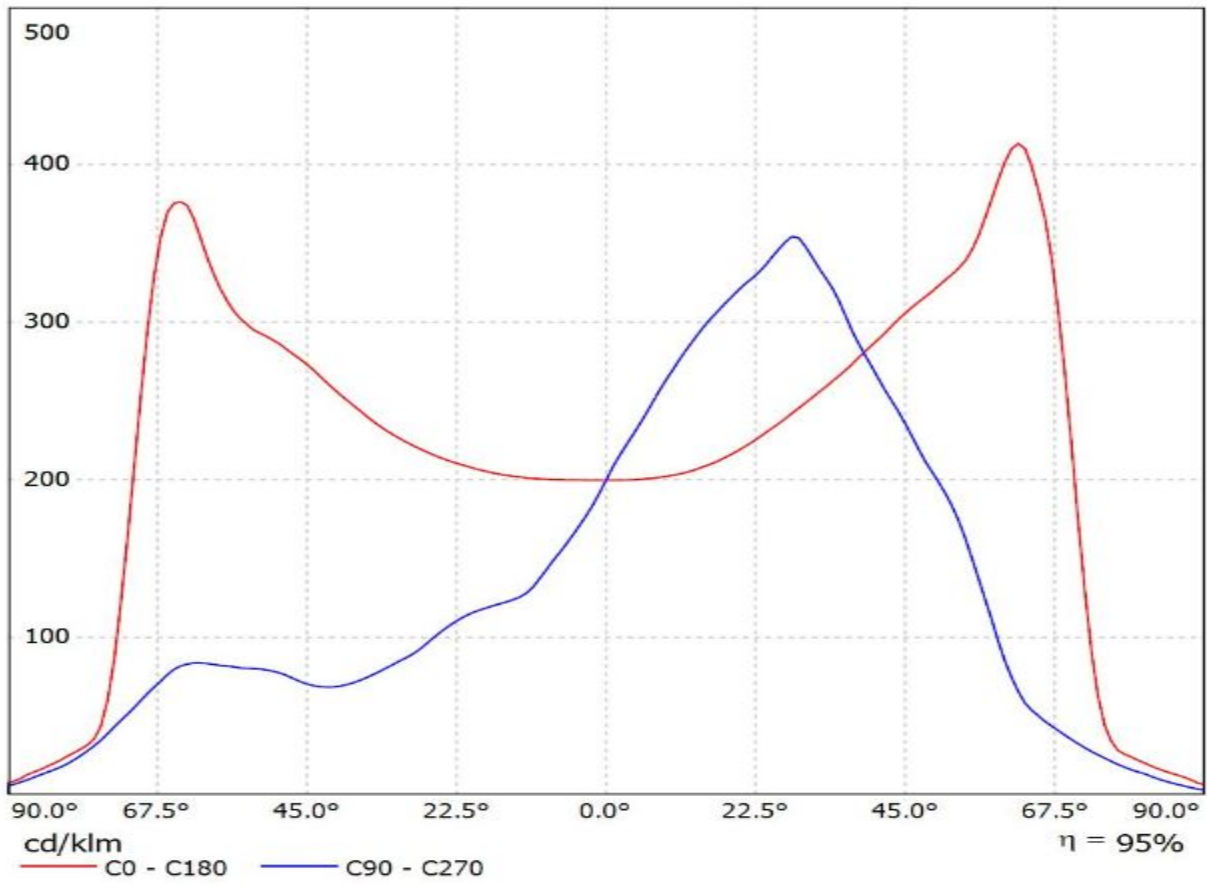

Luminaire: Ledil CS16102_STRADELLA-IP-28-T3_(XT-E)

Lamps: 1 x Cree_XT-E_Stradella-28_1805.68lm@250mA_P=9.51344W_U=38.069V

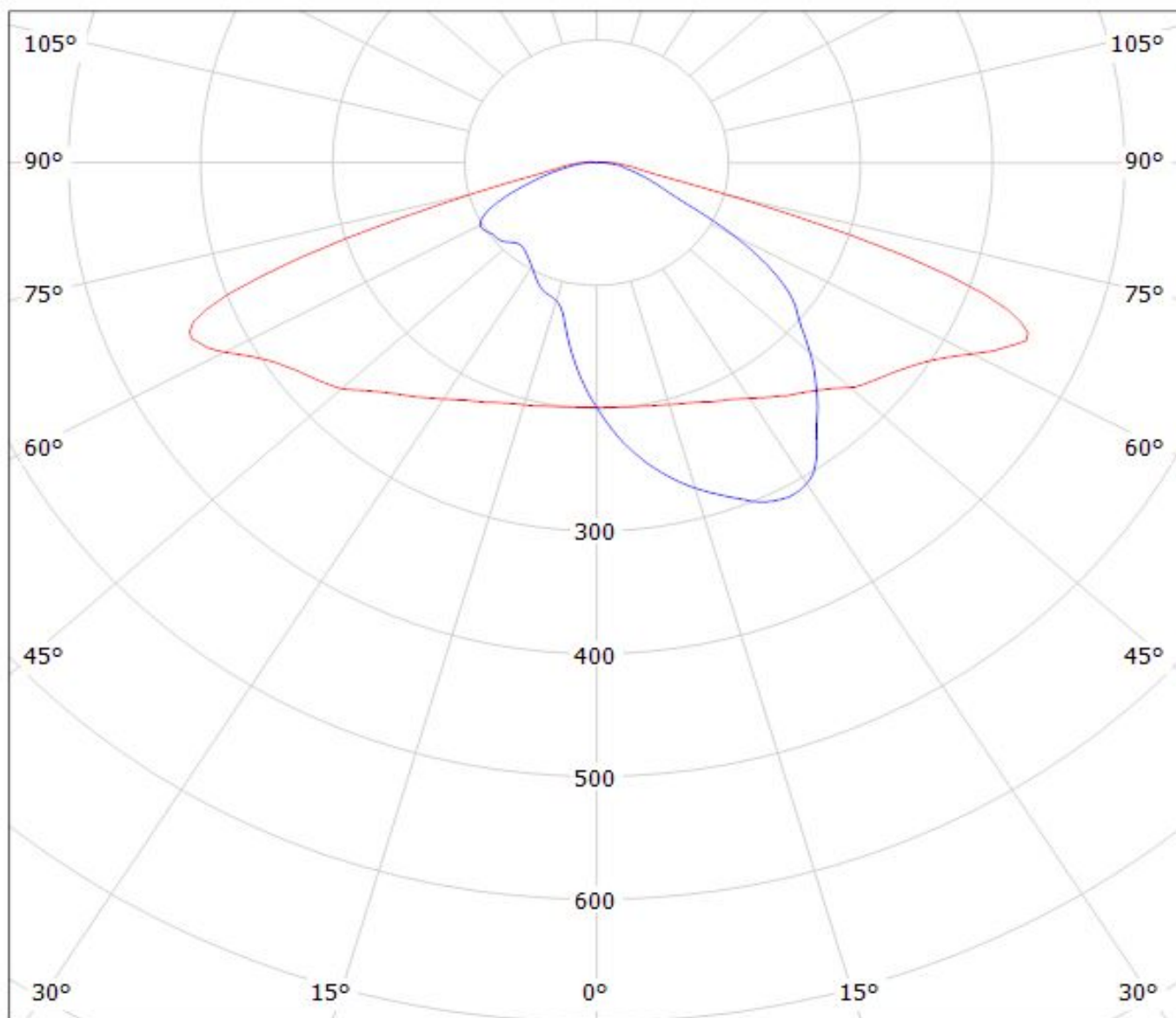

cd/klm

— C0 - C180

— C90 - C270

$\eta = 95\%$

Luminaire: Ledil Oy CS16102_STRADELLA-IP-28-T3_(XP-G3)_SIMULATED
Lamps: 1 x Cree XP-G3

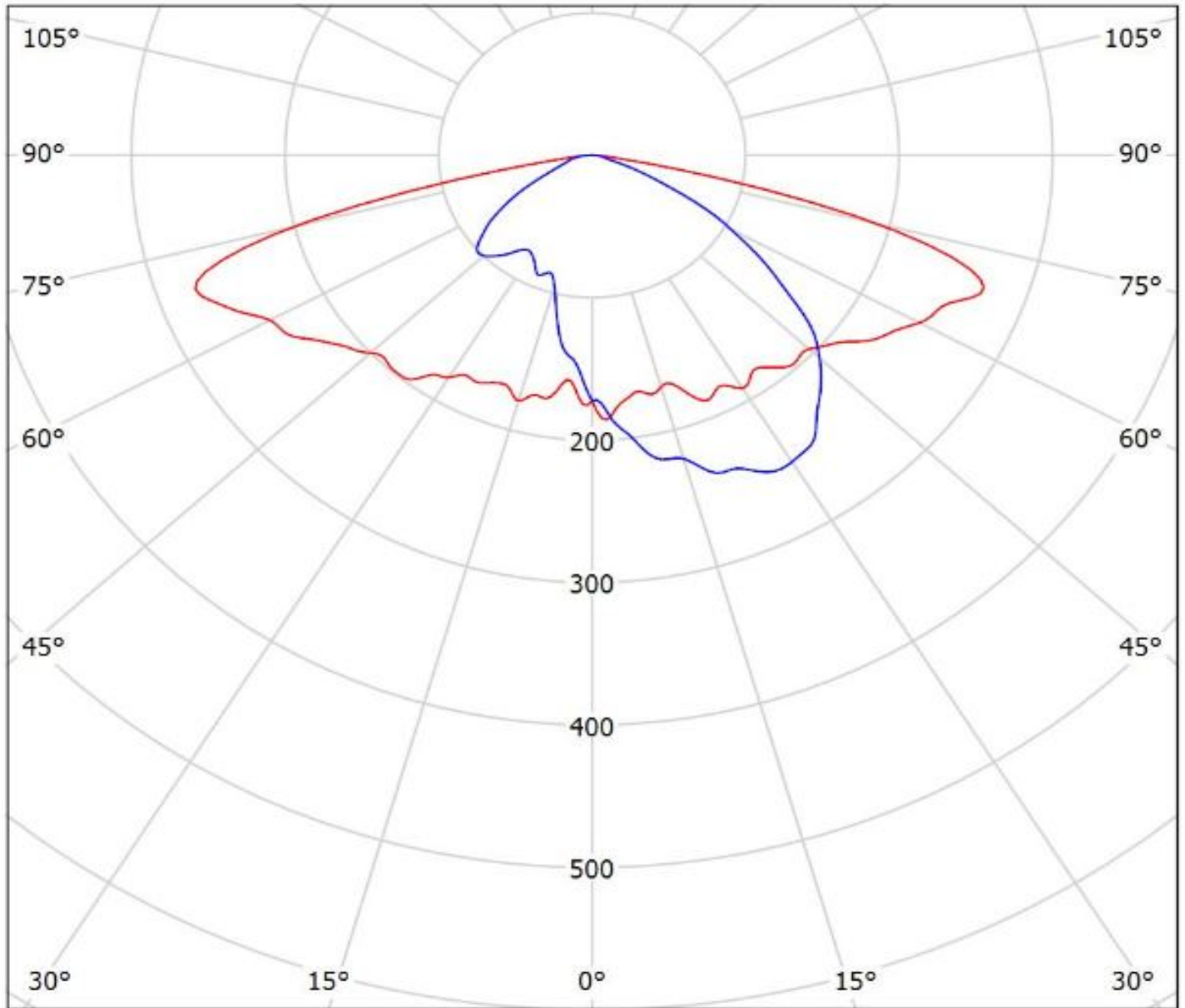

cd/klm

— C0 - C180 — C90 - C270

$\eta = 79\%$

Luminaire: Ledil CS16102_STRADELLA-IP-28-T3_(Luxeon_3030_2D)

Lamps: 1 x Lumileds_Luxeon_3030_2D_1132.31lm@240mA_P=9.57624W_U=39.901V

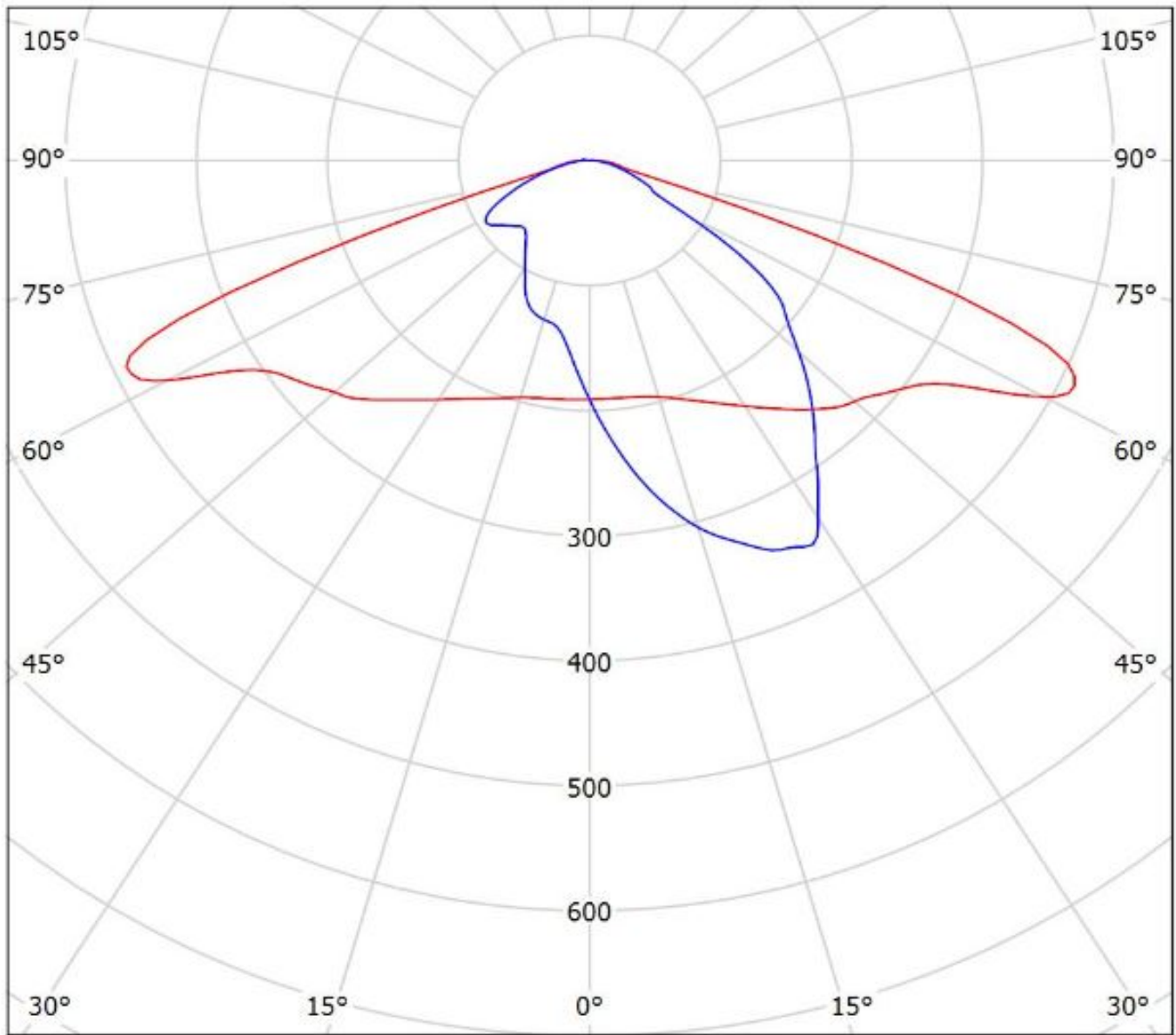

cd/klm

— C0 - C180 — C90 - C270

$\eta = 96\%$

Luminaire: Ledil CS16102_STRADELLA-IP-28-T3_(Duris_S5)

Lamps: 1 x Osram_Duris_S5_Stradella28_(GW_PSLR32.EM-JQJS-A333-1)_786.457lm@250mA_P=4.90979W_I=0.250A

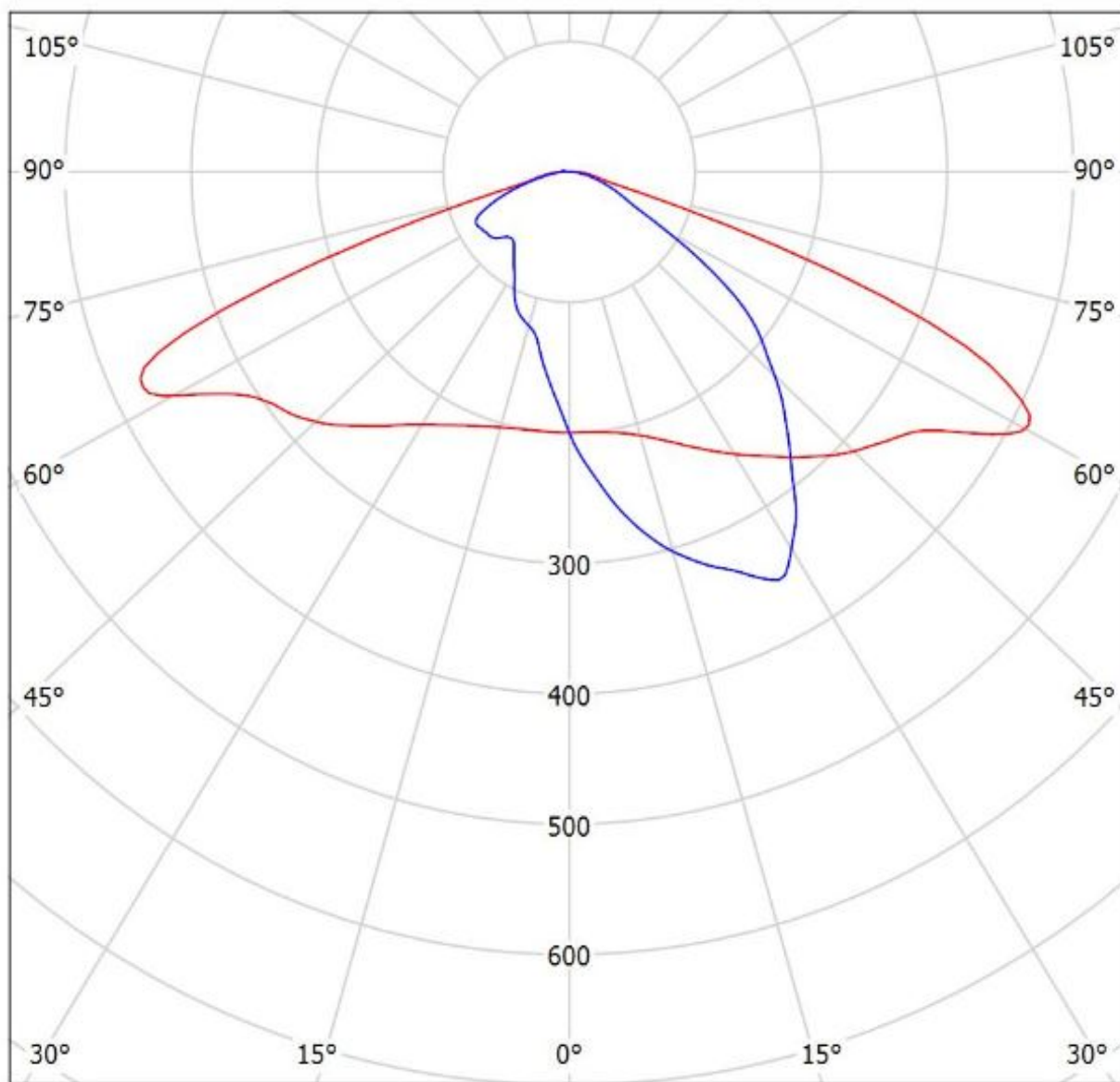

cd/klm

— C0 - C180 — C90 - C270

$\eta = 95\%$

NOTE: The typical divergence will be changed by different color, chip size and chip position tolerance. The typical total divergence is the full angle measured where the luminous intensity is half of the peak value.